

IFP51 Series

Commercial Touch Display

User Guide

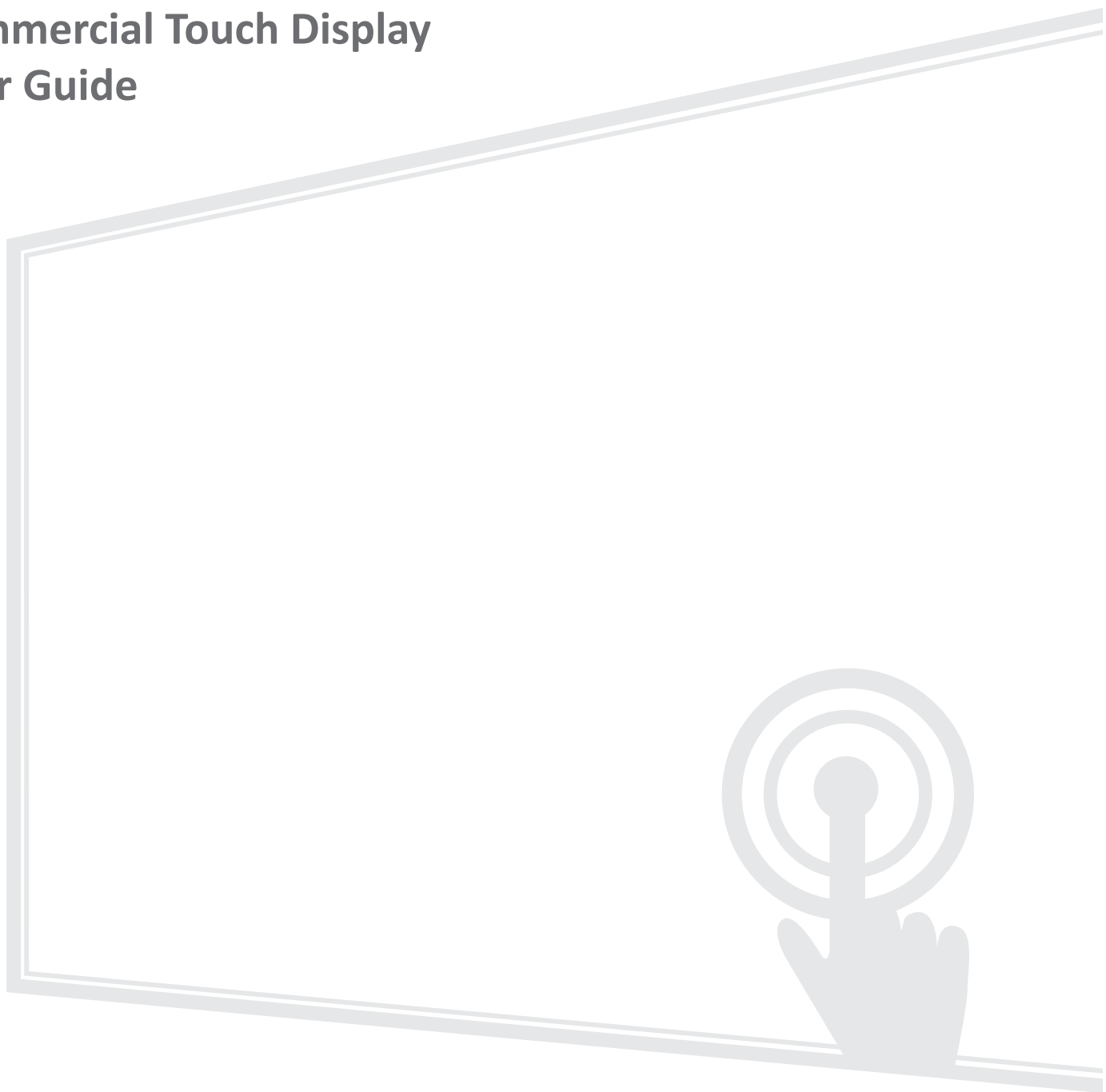

IMPORTANT: Please read this User Guide to obtain important information on installing and using your product in a safe manner, as well as registering your product for future service. Warranty information contained in this User Guide will describe your limited coverage from ViewSonic® Corporation, which is also found on our web site at <http://www.viewsonic.com> in English, or in specific languages using the Regional selection box of our website.

Model No. VS20432 | VS20640 | VS20641 | VS20434 | VS20435
P/N: IFP5551 | IFP6551 | IFP7551 | IFP8651 | IFP9851

Thank you for choosing ViewSonic®

As a world-leading provider of visual solutions, ViewSonic® is dedicated to exceeding the world's expectations for technological evolution, innovation, and simplicity. At ViewSonic®, we believe that our products have the potential to make a positive impact in the world, and we are confident that the ViewSonic® product you have chosen will serve you well.

Once again, thank you for choosing ViewSonic®!

Safety Precautions

Please read the following **Safety Precautions** before you start using the device.

- Keep this user guide in a safe place for later reference.
- Read all warnings and follow all instructions.
- Do not use the device near water. To reduce the risk of fire or electric shock, do not expose the device to moisture.
- Never remove the rear cover. This display contains high-voltage parts. You may be seriously injured if you touch them.
- Avoid exposing the device to direct sunlight or other sources of sustained heat.
- Do not install near any heat sources such as radiators, heat registers, stoves, or other devices (including amplifiers) that may increase the temperature of the device to dangerous levels.
- Use a soft, dry cloth to clean the external housing. For more information, refer to the "Maintenance" section.
- When moving the device, be careful not to drop or bump the device on anything.
- Do not place the device on an uneven or unstable surface. The device may fall over resulting in an injury or a malfunction.
- Do not place any heavy objects on the device or connection cables.
- If smoke, an abnormal noise, or a strange odor is present, immediately turn the device off and call your dealer or ViewSonic®. It is dangerous to continue using the device.
- The device is a monitor with an LED backlight intended for general office use.
- Do not attempt to circumvent the safety provisions of the polarized or grounding-type plug. A polarized plug has two blades with one wider than the other. A grounding-type plug has two blades and a third grounding prong. The wide blade and the third prong are provided for your safety. If the plug does not fit into your outlet, obtain an adapter and do not attempt to force the plug into the outlet.
- When connecting to a power outlet, DO NOT remove the grounding prong. Please ensure grounding prongs are NEVER REMOVED.
- Protect the power cord from being treaded upon or pinched, particularly at the plug, and at the point where it emerges from the equipment. Ensure that the power outlet is located near the equipment so that it is easily accessible.
- Only use attachments/accessories specified by the manufacturer.
- When a cart is used, use with caution when moving the cart/equipment combination to avoid injury from tipping over.

- Disconnect the power plug from the AC outlet if the device is not being used for a long period of time.
- Place the device in a well-ventilated area. Do not place anything on the device that prevents heat dissipation.

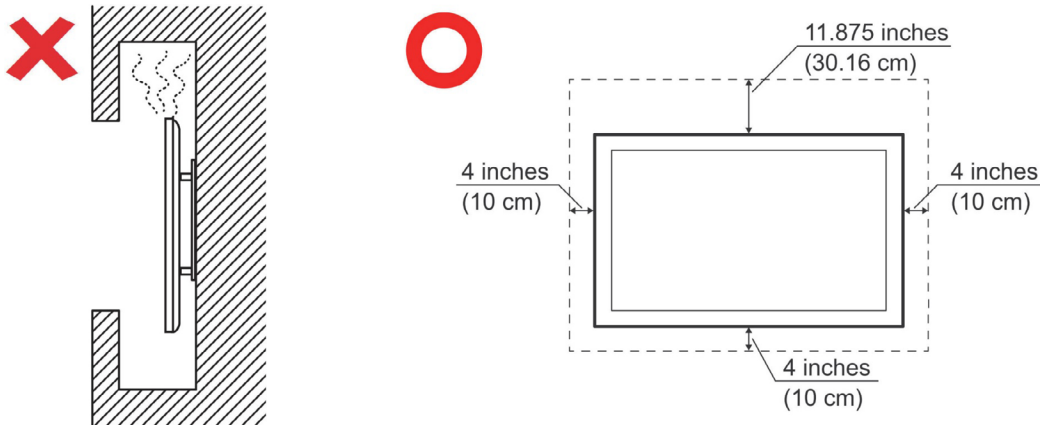

- Refer all servicing to qualified service personnel. Service will be required when the unit has been damaged in any way, such as:
 - » if the power supply cord or plug is damaged
 - » if liquid is spilled onto or objects fall in the unit
 - » if the unit is exposed to moisture
 - » if the unit does not operate normally or has been dropped

IMPORTANT

To ensure the optimal performance and longevity of your display, it is essential to follow the recommended handling, mounting, and storage procedures. Placing the display in a horizontal position can lead to a range of potential issues, including:

- Excessive stress on the display's structural components, resulting in the formation of cracks or distortions along the edges.
- Uneven weight distribution, which can cause the screen to warp, sustain internal damage, or crack over time.
- Thermal-related damage, as the internal components may not be able to dissipate heat as intended, leading to potential failure or permanent damage.

Furthermore, altering the display's form can also compromise the integrity of its internal components, including the sensitive LCD cells, which can result in a permanent degradation of the display's quality.

To prevent such issues and maintain the display's optimal condition, it is recommended to always mount, handle, transport, and store it in a vertical position. Failure to do so may void the warranty and compromise the display's performance and lifespan.

NOTE: Any damage resulting from the misuse or improper handling of the display is not covered under warranty.

Contents

Safety Precautions.....	3
Introduction	10
Package Contents	10
Wall Mount Kit Specifications (VESA)	11
Product Overview	12
IFP5551.....	12
IFP6551.....	13
IFP7551.....	14
IFP8651.....	15
IFP9851.....	16
Control Panel.....	17
I/O Panels	18
Front I/O	19
Rear I/O	20
Side I/O.....	21
Remote Control	23
Using Gestures	26

Making Connections 28

Connecting to Power	28
Connecting to Video Inputs and Enabling Touch.....	29
USB Type C Connection	30
HDMI Connection	30
DisplayPort Connection.....	30
VGA Connection	30
RS-232 Connection	31
USB and Network Connections.....	32
USB Type A	32
Network and Modem	32
Media Connection	33
Audio Connection	34
Audio In	34
Audio Out	34
SPDIF Connection	34
Video Output Connection	35
HDMI Out	35
Optional Connections	36
Slot-in PC (OPS Slot) Installation	36
Wi-Fi Card (Wi-Fi Slot) Installation	37

Using Your ViewBoard 38

Turning On/Off the ViewBoard.....	38
Initial Launch Setup	39
Home Screen	46
How to Sign Up.....	46
Use as Guest.....	47
Sign In.....	47
Home Screen Message.....	48
Toolbar	49
Toolbar Icons.....	50
On-Screen Display (OSD) Menu - General Settings	52
Input Settings	54
Display Settings	56
Eye Care.....	58
Applications	60

ViewBoard Settings	61
ViewBoard Launcher	61
Wireless & Network	61
Wi-Fi	62
Ethernet	64
Bluetooth.....	65
VPN.....	66
Display	68
Wallpaper	69
Protection.....	69
HDMI Out	70
Preference.....	71
Marker.....	72
Touch	72
Language	72
Keyboard & Input Method	73
Date & Time	73
Boot Mode & Advanced Settings.....	74
Startup & Shutdown.....	76
Toolbar Setting	78
Sound Setting	78
Input Source	79
Label Input Source.....	80
Source.....	81
Apps	82
Apps.....	83
System	85
Launcher Scheme	86
Storage	86
Clone to USB.....	87
Display ID.....	88
Security.....	89
System Update	92
About Device	93

Android Launcher	94
Network & Internet.....	94
Connected Devices.....	96
Apps	97
Notifications.....	98
Storage.....	100
Sound	101
Display.....	102
Wallpaper & Style.....	103
Accessibility.....	104
Security & Privacy.....	106
Passwords & Accounts	108
Digital Wellbeing	109
Google	110
Advanced.....	111
System.....	112
About Device	113
Tips & Support.....	114
Android Settings Menu Tree	115
Pre-installed Applications and Settings.....	160
AirSync.....	160
myViewBoard Manager	161
myViewBoard Whiteboard	162
RS-232 Protocol.....	165
Description	165
RS-232 Hardware Specification	165
LAN Hardware Specification.....	166
RS-232 Communication Setting.....	166
LAN Communication Setting	166
Command Message Reference.....	166
Protocol	167
Set-Function Listing.....	167
Get-Function Listing	175
Remote Control Pass-through Mode	183

Appendix.....	186
Display Modes	186
DisplayPort	186
HDMI	187
USB Type C	187
VGA	188
HDMI Out	188
Troubleshooting	189
Maintenance.....	191
General Precautions	191
Cleaning the Screen.....	191
Cleaning the Case	191
Regulatory and Service Information	192
Compliance Information.....	192
FCC Compliance Statement.....	192
Industry Canada Statement.....	192
CE Conformity for European Countries.....	193
Declaration of RoHS2 Compliance.....	194
ENERGY STAR Statement.....	195
Indian Restriction of Hazardous Substances	196
Product Disposal at End of Product Life	196
Copyright Information	197
Customer Service	198
Limited Warranty	199
Mexico Limited Warranty.....	202

Introduction

Package Contents

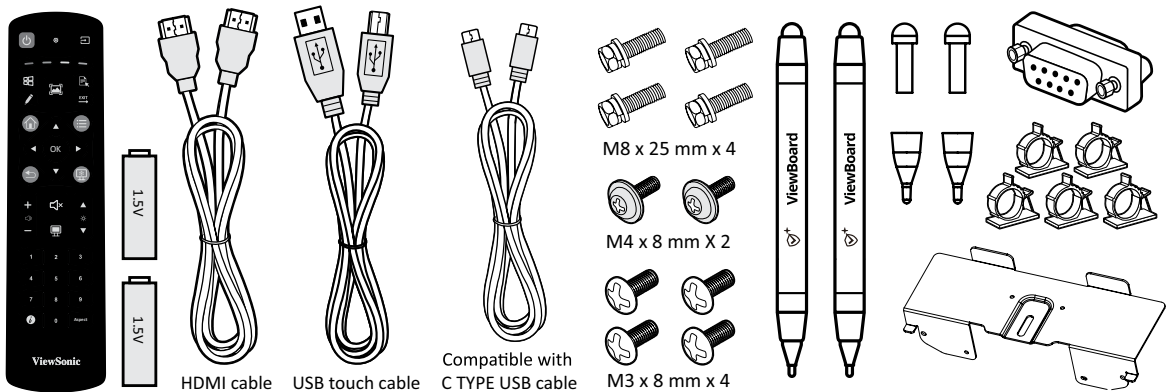
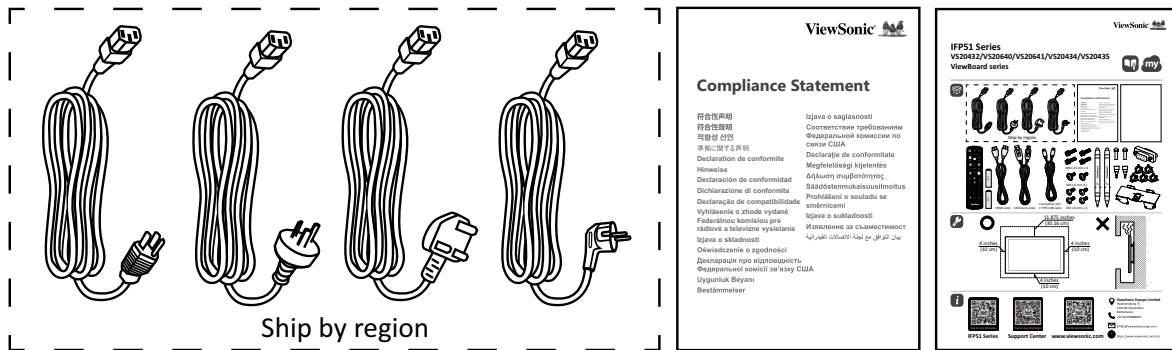

- AAA Batteries
- Camera Plate
- 5 x Clamps
- Compliance Statement
- HDMI Cable (3 m)
- Power Cord (3 m)
- Quick Start Guide
- Wi-Fi Module (optional)
- 4 x Replacement Pen Nibs
- USB Type C Cable (1.8 m)
- RS-232 Adapter
- 10 x Screws
- 2 x Touch Pens
- USB Touch Cable (3 m)
- Remote Control

NOTE: The cables included in your package may vary depending on your country. Please contact your local reseller for more information.

Wall Mount Kit Specifications (VESA)

NOTE: The following illustration is for instructional purpose only. For details, please refer to the actual product and follow the instructions in the wall mount installation guide to install your wall mount. If attaching to other building materials, please contact your nearest dealer.

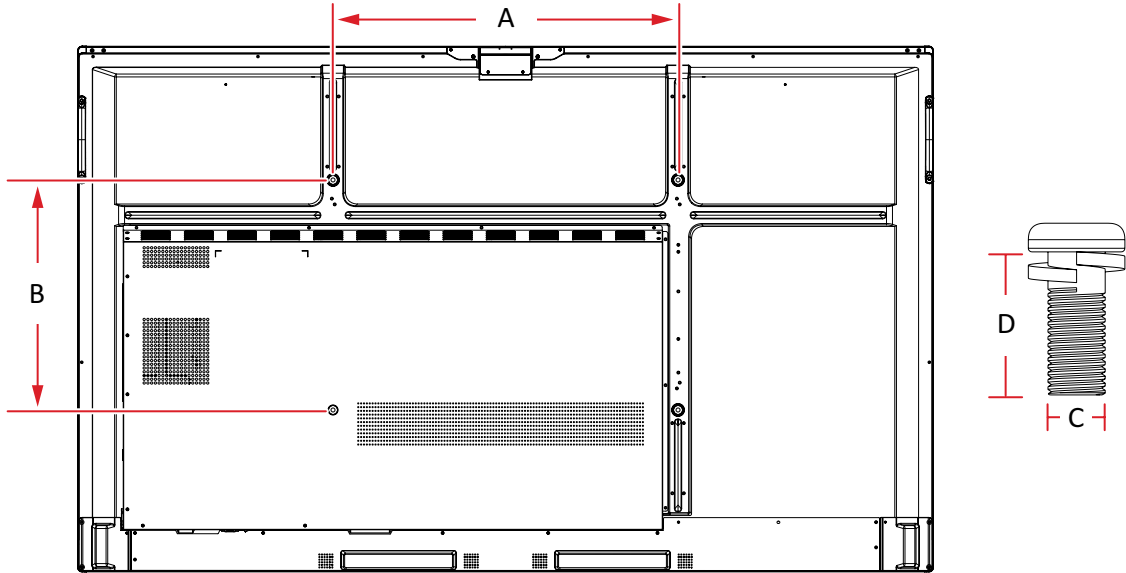

Model	VESA Spec. (A x B)	Standard Screw (C x D)	Quantity
IFP5551	400 x 200 mm	M8 x 25 mm	4 Pieces
IFP6551	600 x 400 mm		
IFP7551	800 x 400 mm		
IFP8651	800 x 600 mm		
IFP9851	800 x 600 mm		

NOTE:

- Do not use screws that are longer than the standard dimension, as they may cause damage to the inside of the display.
- Only mount the display in landscape orientation. Never mount in a portrait orientation.

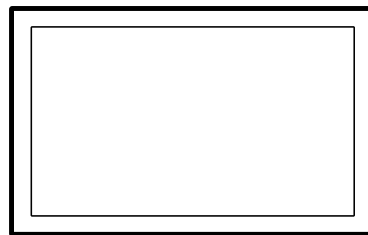
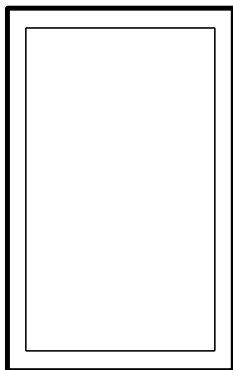

Product Overview

IFP5551

Front Panel

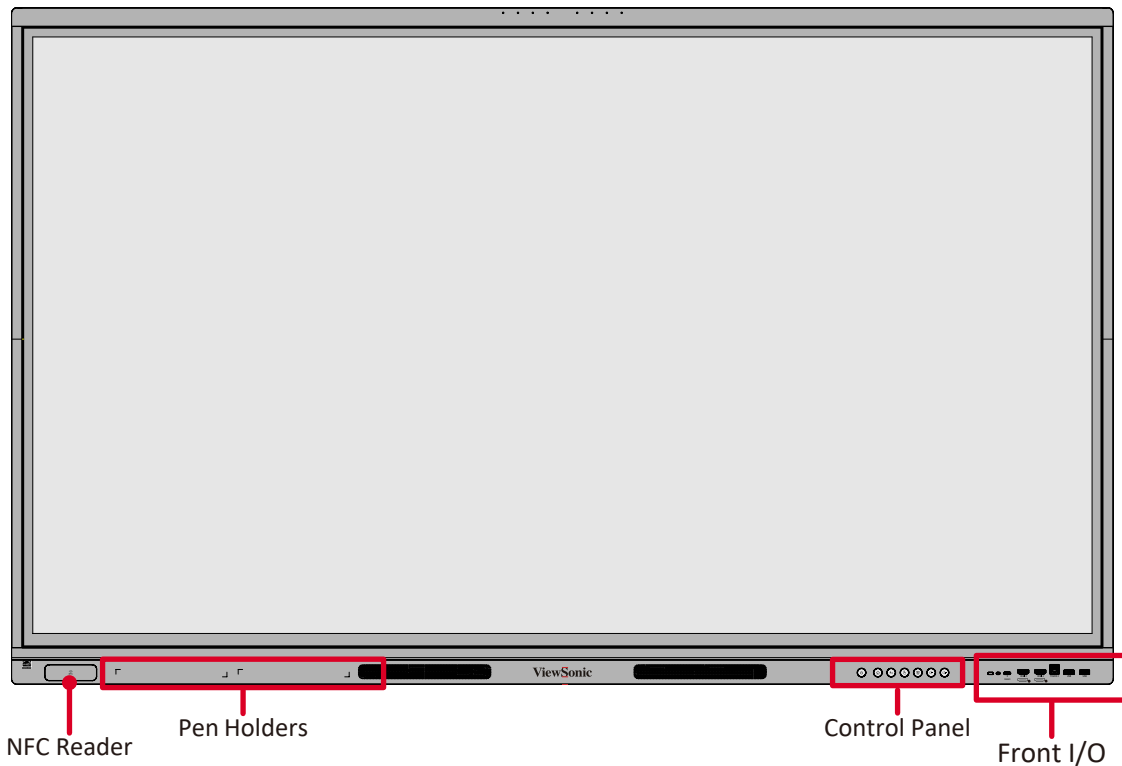

Rear Panel

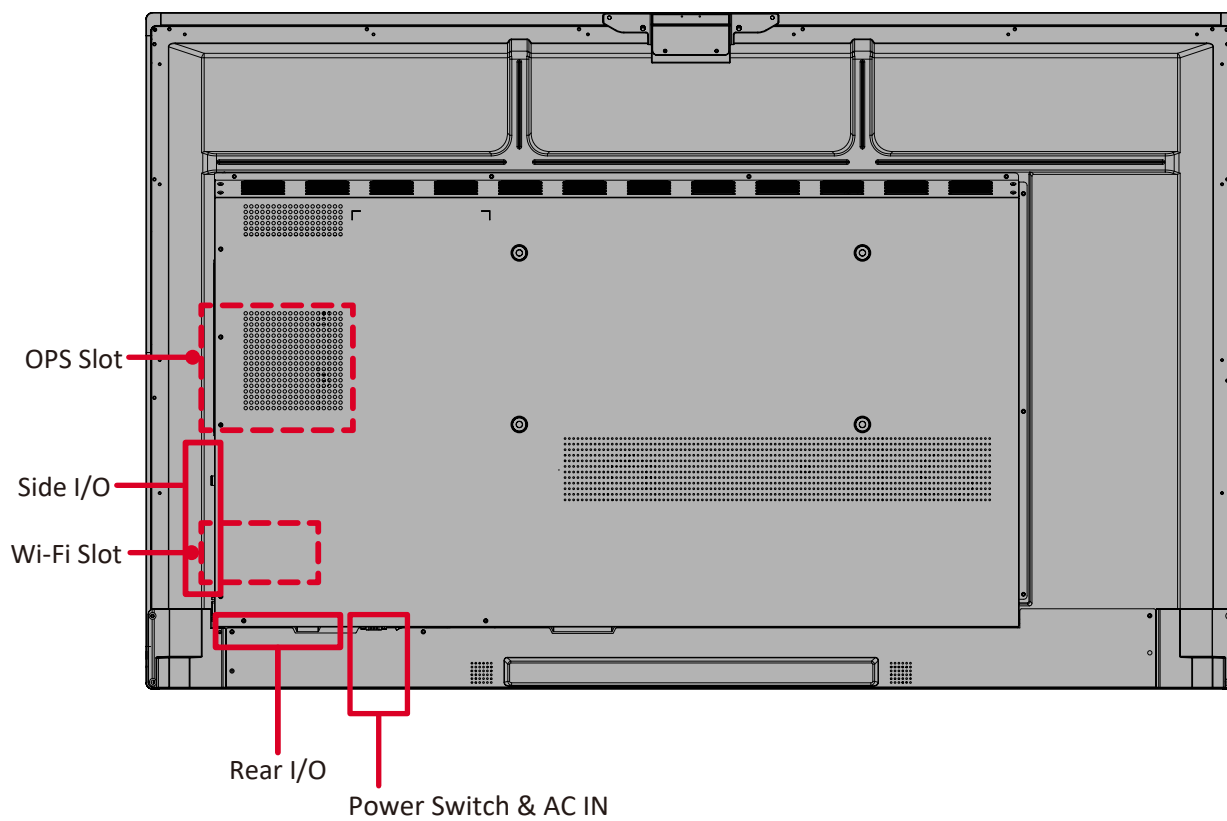

IFP6551

Front Panel



Rear Panel

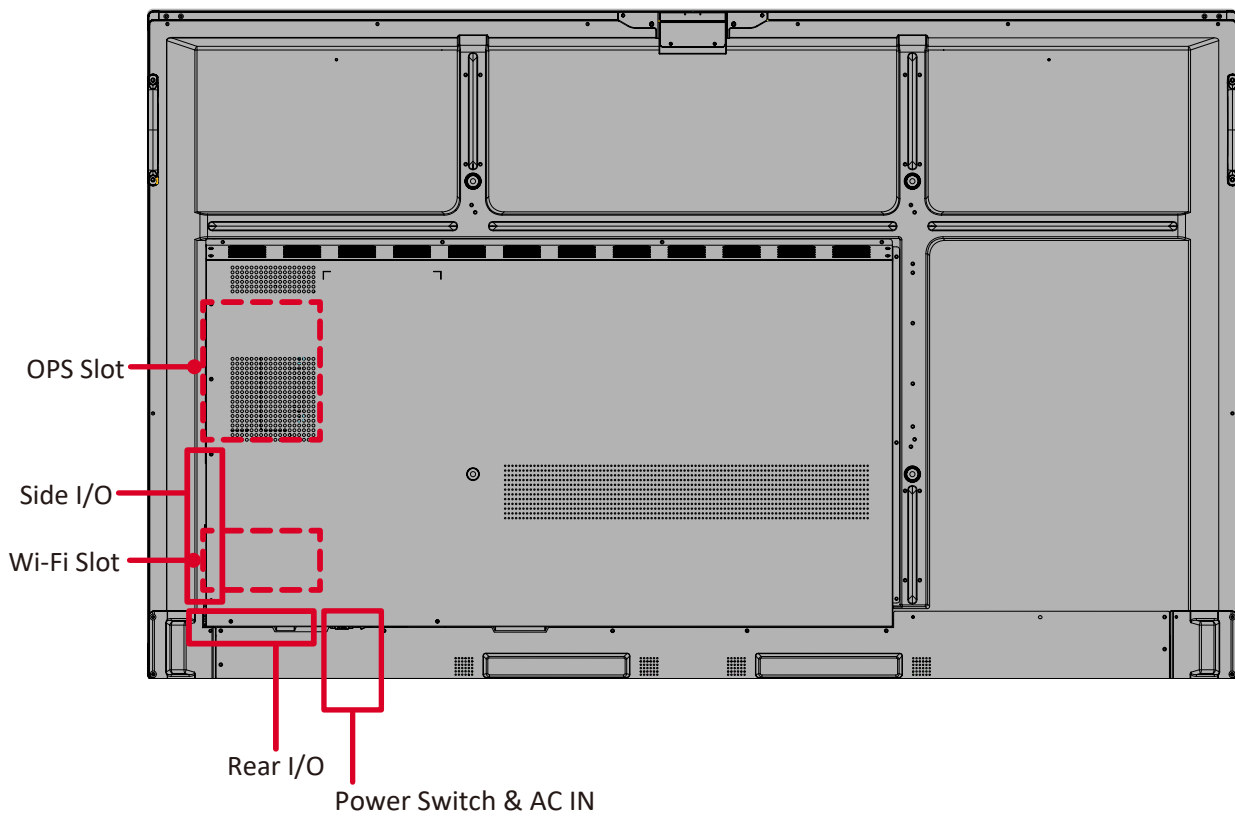

IFP7551

Front Panel



Rear Panel

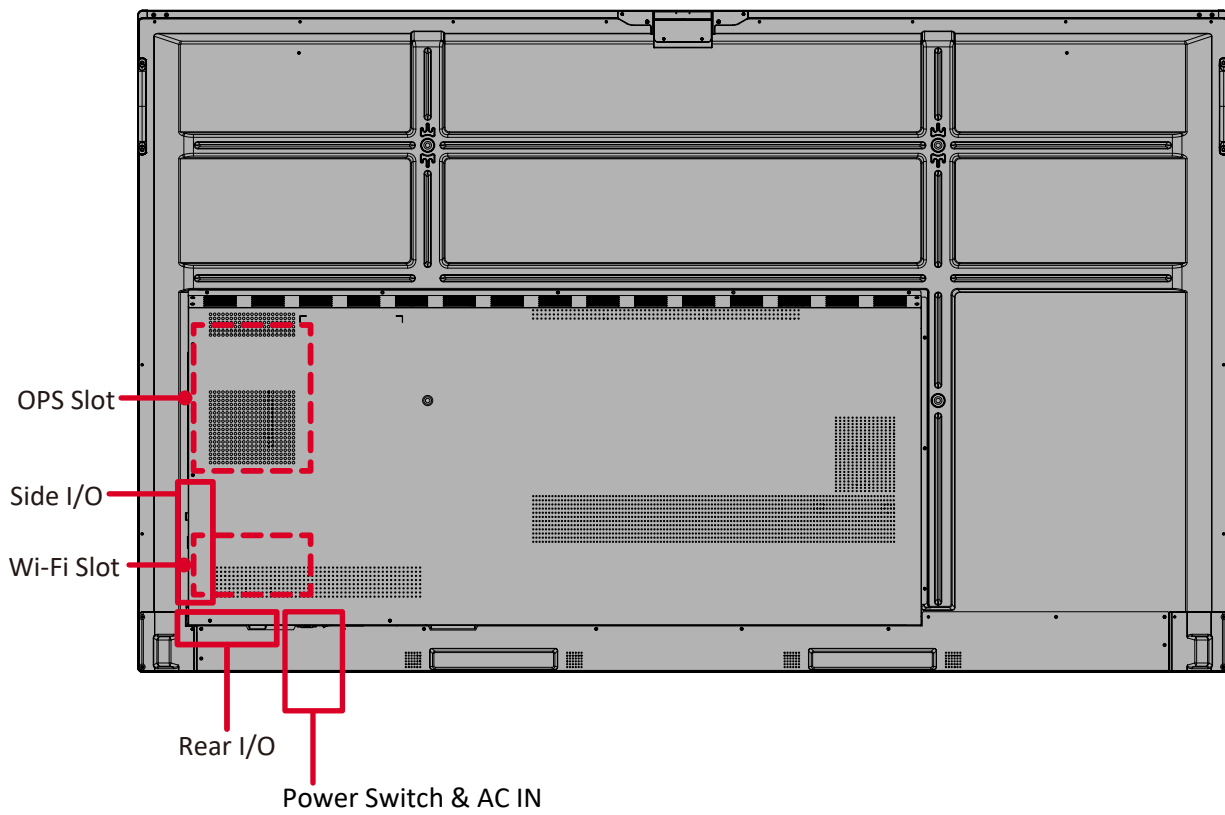

IFP8651

Front Panel



Rear Panel

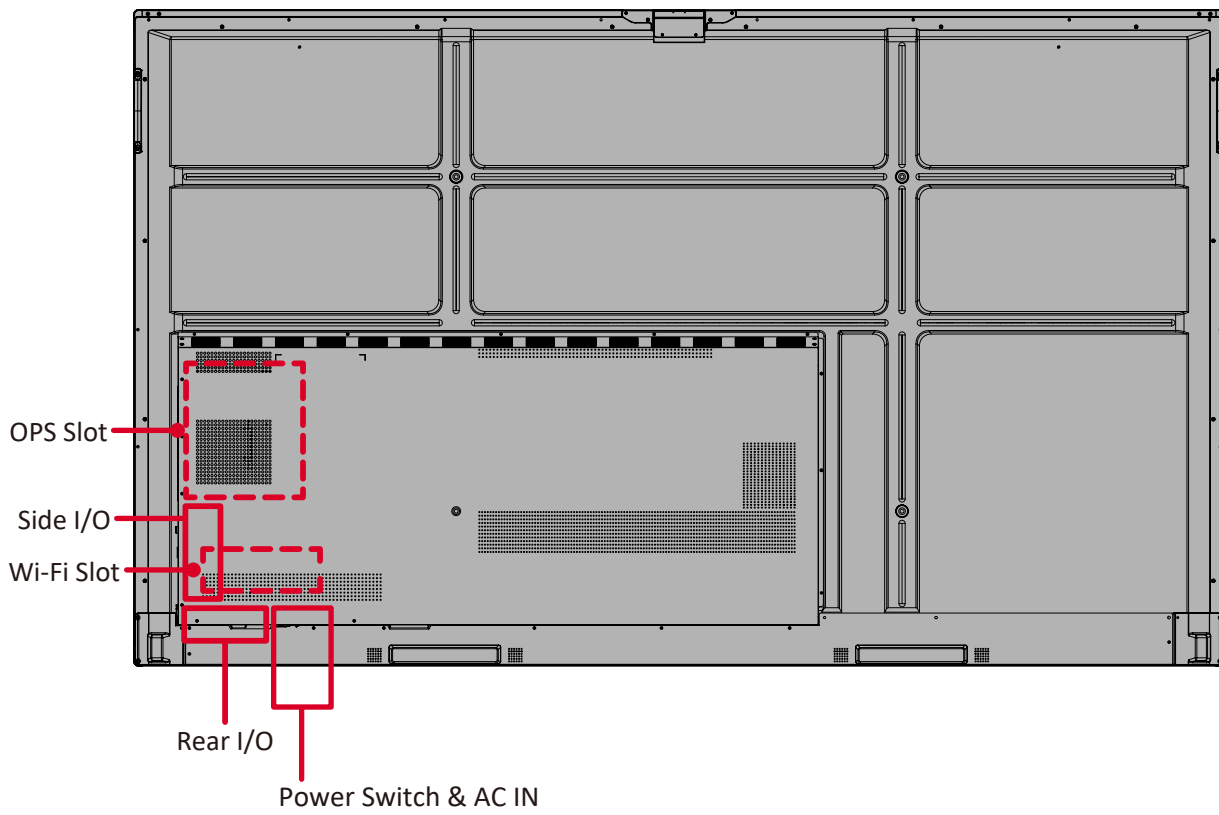

IFP9851

Front Panel





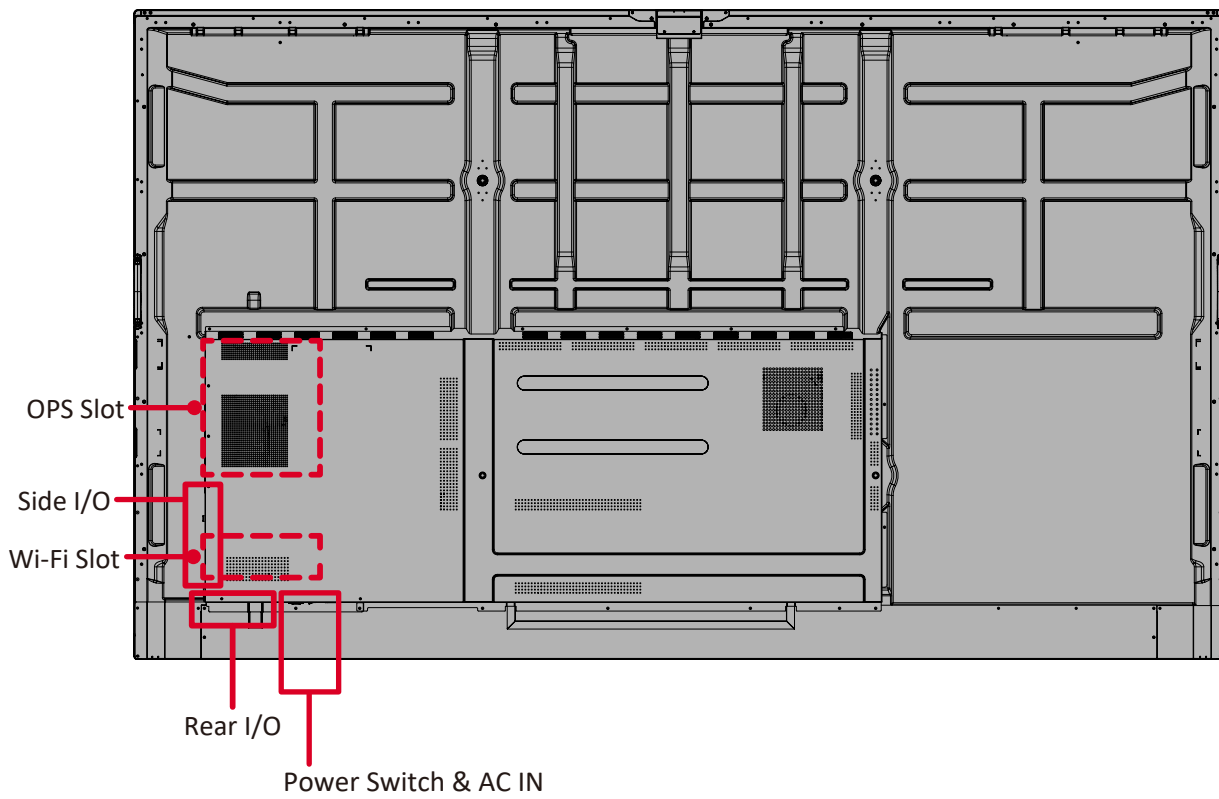



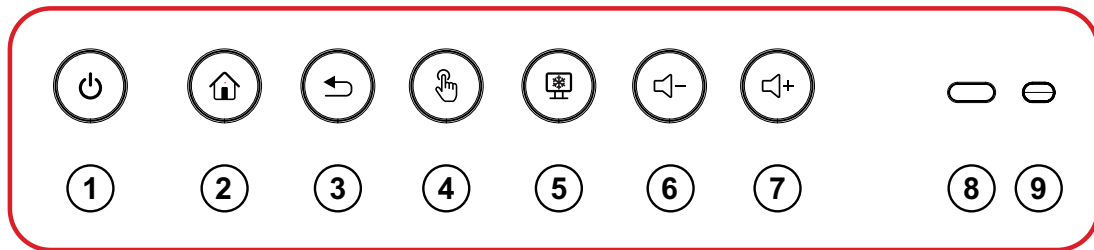

Rear Panel



Control Panel



Number	Item	Description
1		<ul style="list-style-type: none"> • Power indicator light. • Press to turn on the display. • Once on, press again to turn on or off the backlight only. • Once on, press and hold to turn off the display.
2		Return to the ViewBoard's main interface.
3		Return to the previous interface level (i.e., go back to a previous screen).
4		Enable or disable the touch screen function.
5		Freeze the current image on the screen.
6		Decrease the sound level.
7		Increase the sound level.
8		Remote control IR receiver.
9		Ambient light sensor.



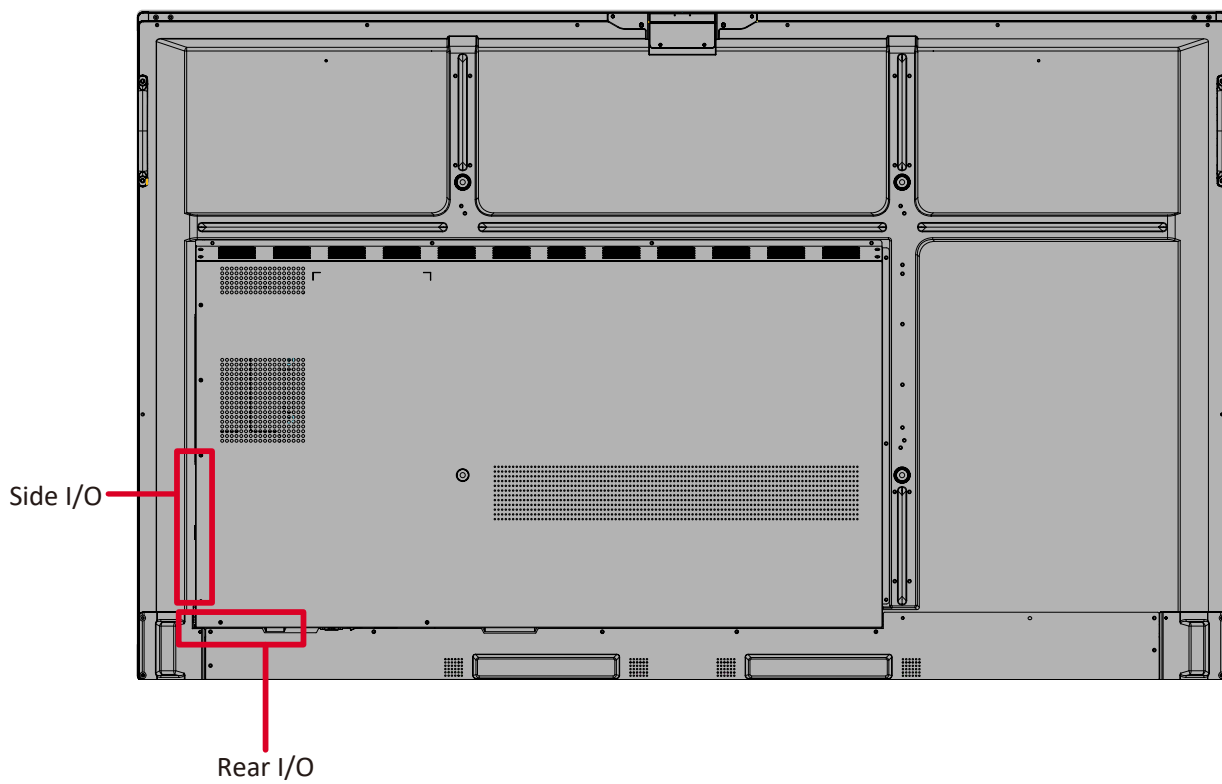

I/O Panels

NOTE: The following illustrations are for instructional purpose only. For details, please refer to the actual device.

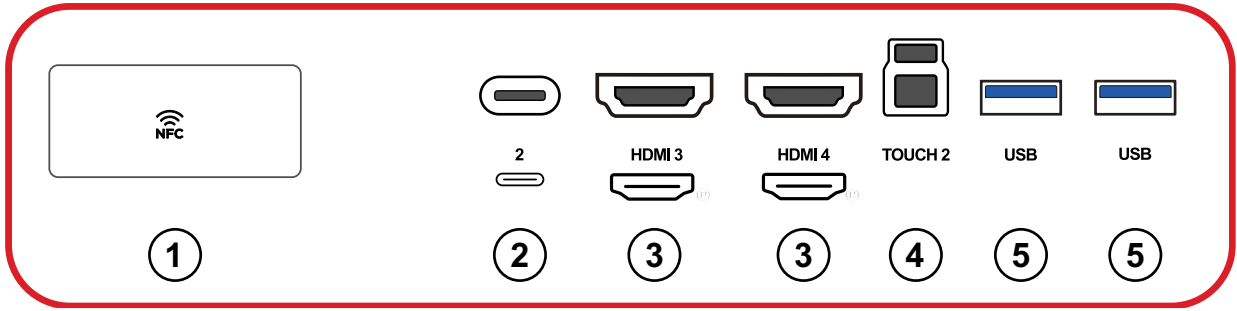

Front I/O

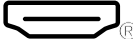

Number	Item	Description
1		NFC reader
2	 (TYPE C 2)	<ul style="list-style-type: none"> • USB Type C input • USB 3.2 Gen 1 standard • Supports DP v. 1.2 with audio, video, and touch • Supports LAN by 10M/100M • Supports power charge up to 65W¹. Power charge supported: 5V/3A, 9V/3A, 15V/3A, 20V/3.25A
3	 (HDMI 3/4)	<ul style="list-style-type: none"> • HDMI input • Connect to a computer with HDMI output, set-top box, or other video device • Supports 4K display; HDMI v. 2.1; CEC
4	TOUCH 2	<ul style="list-style-type: none"> • USB Type B • Touch signal output to external computer • After connection (with an external computer), the device connected to the USB port can directly be used by the external computer <p>NOTE: Pairs with the HDMI 3/4 port () next to it.</p>
5	USB	<ul style="list-style-type: none"> • USB Type A input • USB 3.2 Gen 1 standard • Connect USB devices such as hard disks, keyboard, mouse, etc. • Automatically switches between the external computer and ViewBoard

1 - Only when OPS PC module (purchase separately) is connected.

Rear I/O

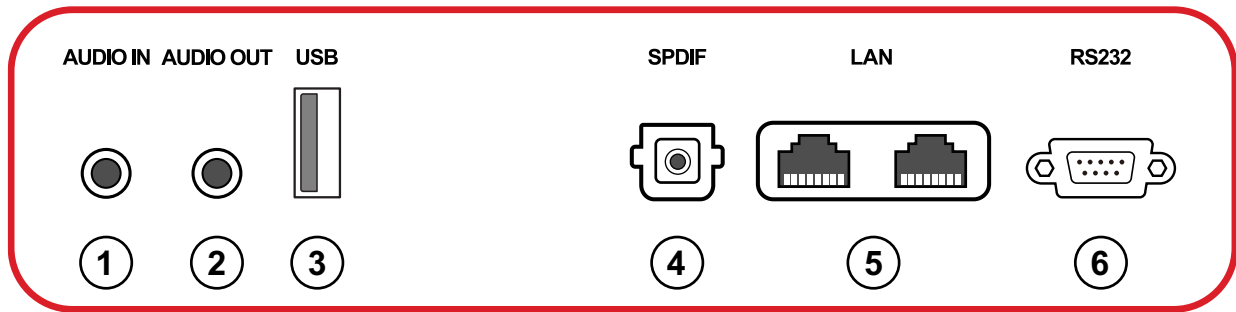

Number	Item	Description
1	AUDIO IN	External computer audio input
2	AUDIO OUT	Audio output to an external speaker/headset
3	USB	<ul style="list-style-type: none"> • USB Type A input • USB 2.0 standard • For ViewBoard source use only
4	SPDIF	Multichannel sound via optical signals
5	LAN	<ul style="list-style-type: none"> • Standard RJ45 (10M/100M/1000M) Internet connection interface • Features hub support for network sharing
6	RS232	Serial interface; used for mutual transfer of data between devices

Side I/O

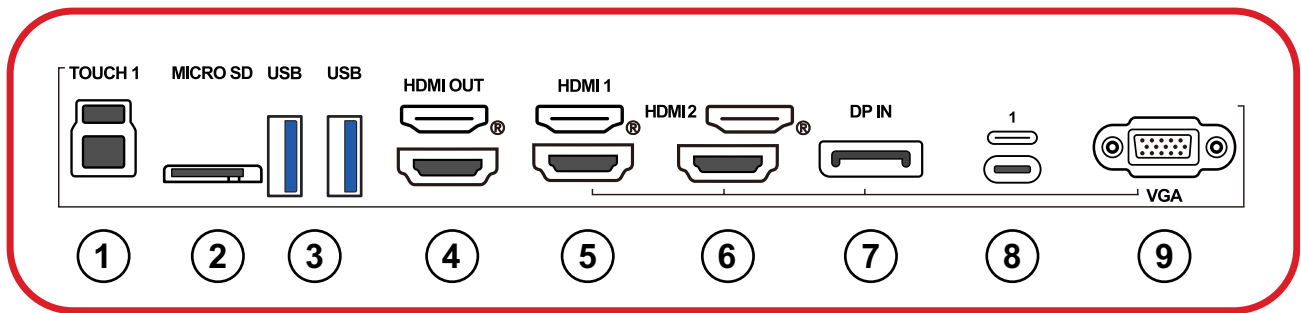

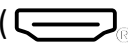
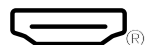
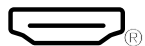
Number	Item	Description
1	TOUCH 1	<ul style="list-style-type: none"> • USB Type B • Touch signal output to external computer • After connection (with an external computer), the device connected to the USB port can directly be used by the external computer <p>NOTE: Pairs with the HDMI ((HDMI 1/2 ()) / DisplayPort (DP IN)/VGA port next to it.</p>
2	MICRO SD	Data only, up to 512 GB
3	USB	<ul style="list-style-type: none"> • USB Type A input • USB 3.2 Gen 1 standard • Connect USB devices such as hard disks, keyboard, mouse, etc. • Automatically switches between the external computer and ViewBoard
4	HDMI OUT	<ul style="list-style-type: none"> • Connect to a computer with HDMI output, set-top box, or other video device • Supported by select models <p>NOTE: CEC and ARC are not supported.</p>
5	 (HDMI 1)	<ul style="list-style-type: none"> • HDMI input • Connect to a computer with HDMI output, set-top box, or other video device • Supports 4K display; HDMI v. 2.1; CEC; ARC
6	 (HDMI 2)	<ul style="list-style-type: none"> • HDMI input • Connect to a computer with HDMI output, set-top box, or other video device • Supports 4K display; HDMI v. 2.1; CEC

Number	Item	Description
7	DP IN	<ul style="list-style-type: none"> • DisplayPort input (v. 1.2) • Supports 4K display
8	 (Type C 1)	<ul style="list-style-type: none"> • USB Type C • For data read/write only • USB 3.0 standard
9	VGA	External computer video input

Remote Control

Number	Description
1	Power on/off
2	Screen capture
3	Startup writing
4	Back to the ViewBoard player Home Screen
5	Back/Return to the previous page
6	Increase/Decrease the Volume
7	Number Keypad
8	Information
9	Input source selection
10	Media control buttons: <ul style="list-style-type: none"> • Red: Play/Pause • Green: Stop • Yellow: Forwards • Blue: Backwards
11	Settings menu
12	Up/Down/Right/Left/OK
13	Freeze screen
14	Mute/Unmute
15	Increase/Decrease Brightness
16	Blank Screen
17	Adjust Aspect Ratio

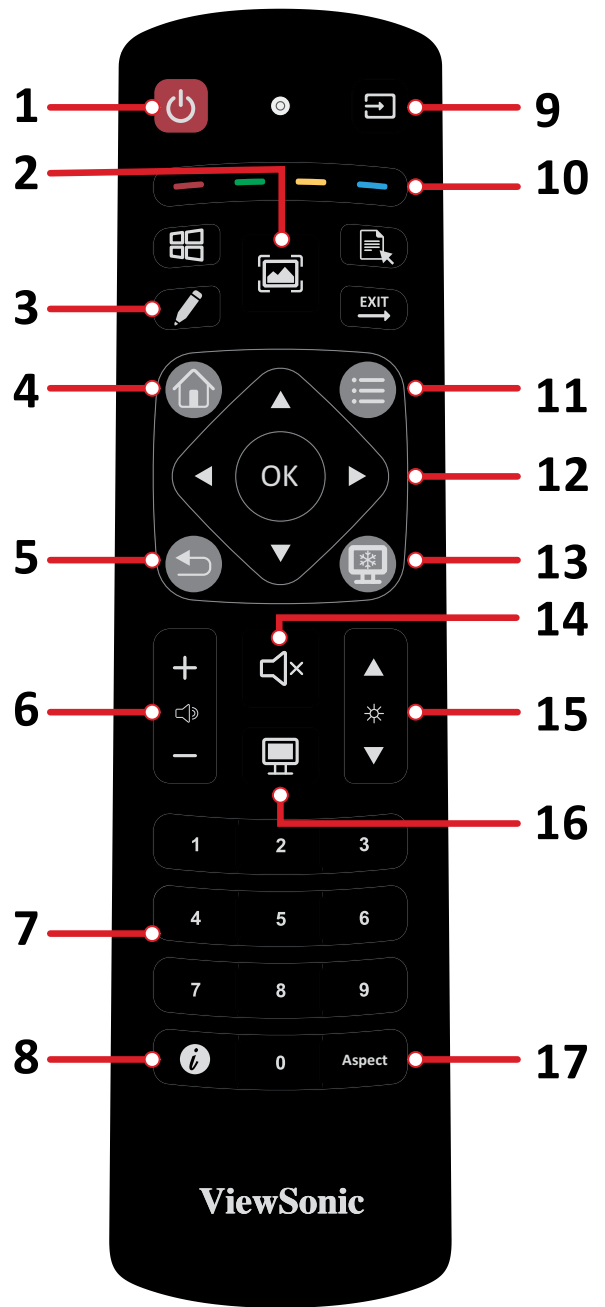

Inserting Remote Control Batteries

To insert batteries into the remote control:

1. Remove the cover on the rear of the remote control.
2. Insert two “AAA” batteries, ensuring the “+” symbol on the battery matches the “+” on the battery post.
3. Replace the cover by aligning it with the slot on the remote control and snapping the latch shut.

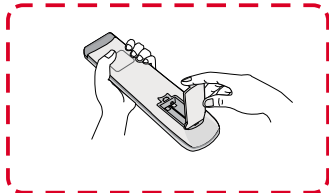

(1)

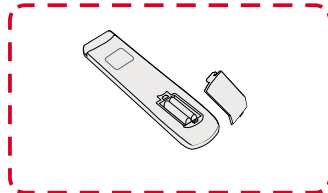

(2)

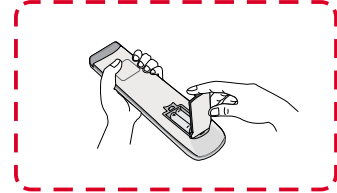

(3)

WARNING: There is a risk of explosion if batteries are replaced with the incorrect type.

NOTE:

- It is recommended that you do not mix battery types.
- Always dispose of old batteries in an environmentally friendly way. Contact your local government for more information on how to dispose of batteries safely.

Remote Control Receiver Range

The working range of the remote control is shown here. It has an effective range of 8 meters, 30° degrees left and right. Ensure there is nothing obstructing the remote control's signal to the receiver.

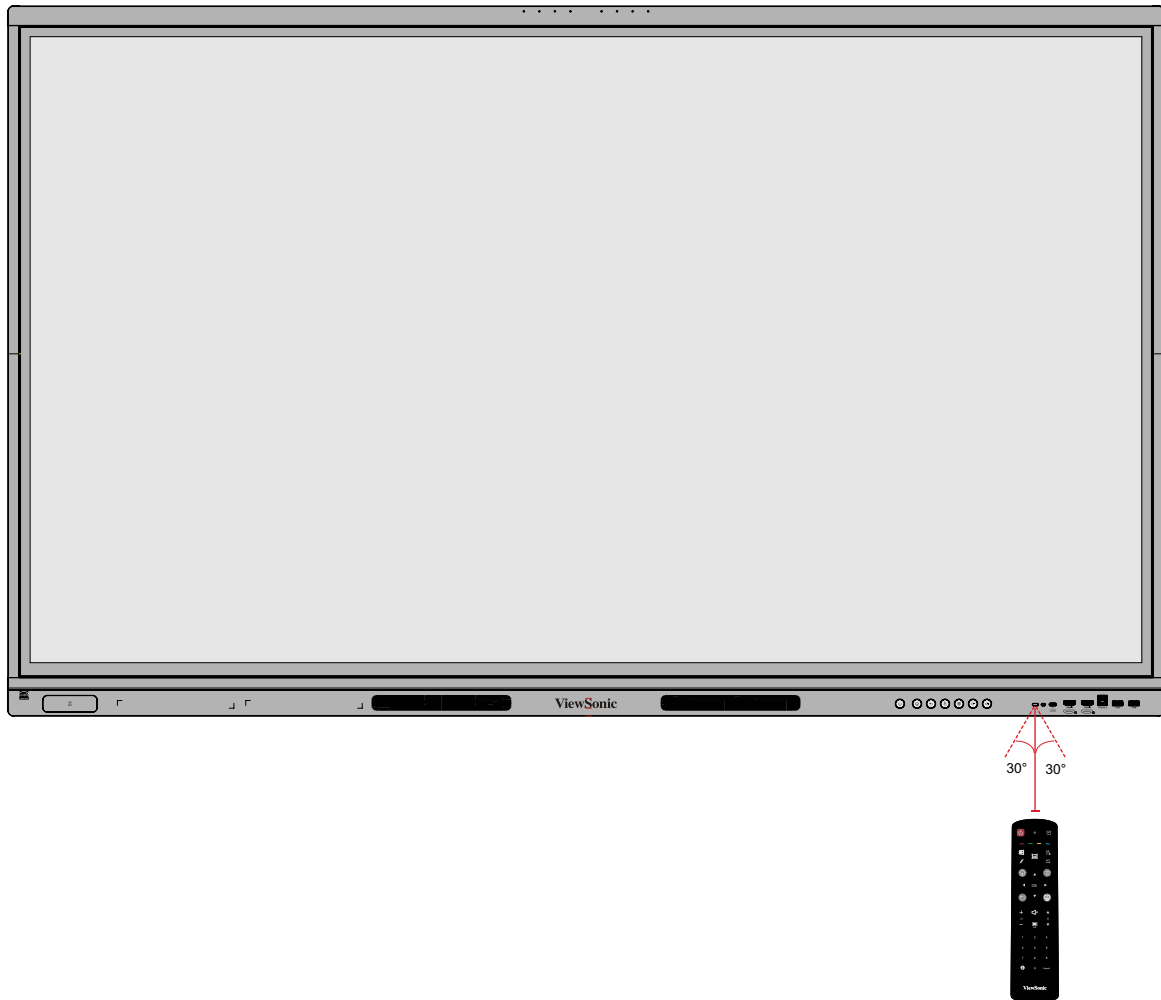

Using Gestures

Touch gestures allow the user to use pre-determined commands without using a keyboard or mouse. Using gestures on the ViewBoard, the user can select/deselect objects, change the location of an object, access settings, erase digital ink, and much more.

Select and Deselect an Object (Clicking)

Press and release the ViewBoard to select/deselect options or objects. This is like a single, standard left mouse click.

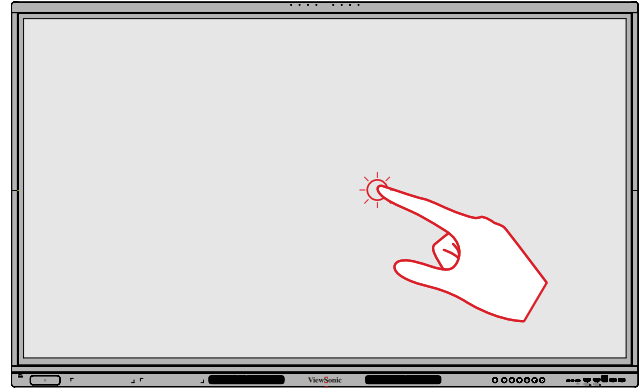

Display Menu Options (Right-Clicking)

Press and hold the ViewBoard with your finger. This is like a single, standard right mouse click.

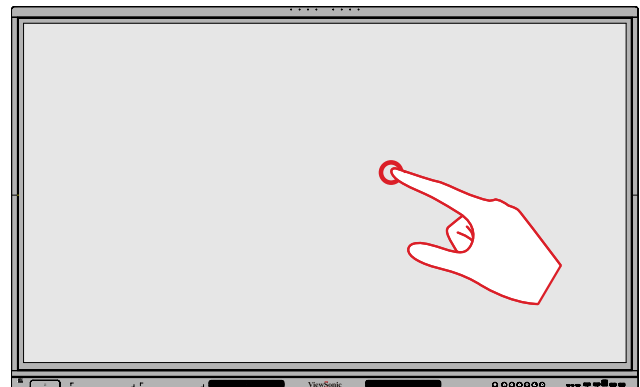

Double-Clicking

Quickly press and release twice in the same location on the ViewBoard. This is like a double, standard left mouse click.

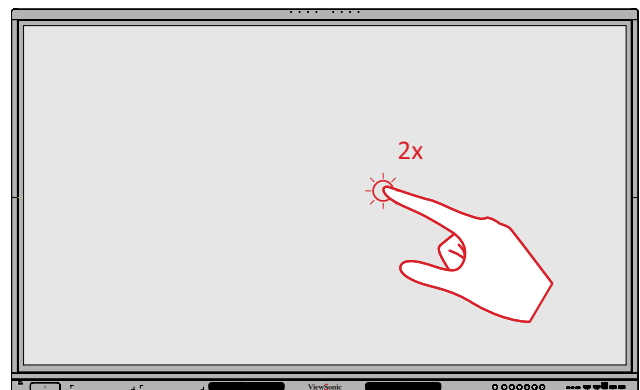

Moving an Object

Press and hold the object on the ViewBoard and slowly drag it with your finger to your desired location.

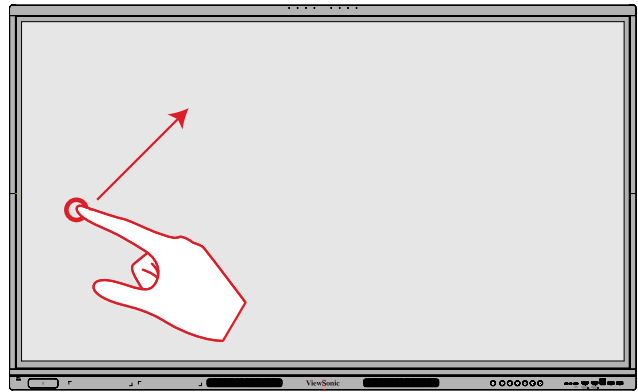

Erasing Digital Ink

Use your flattened hand, palm, or fist on the ViewBoard and move your hand across the area which you wish to erase.

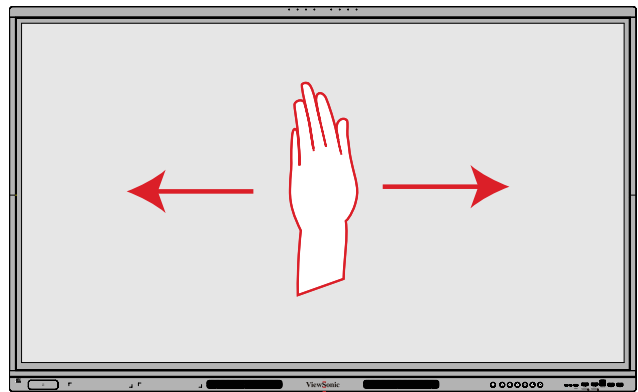

Swipe Up for General Settings

Swipe up from the bottom of the ViewBoard to launch the General Settings.

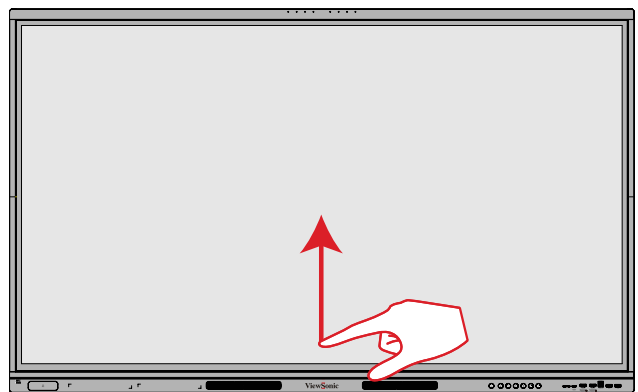

Making Connections

Connecting to Power

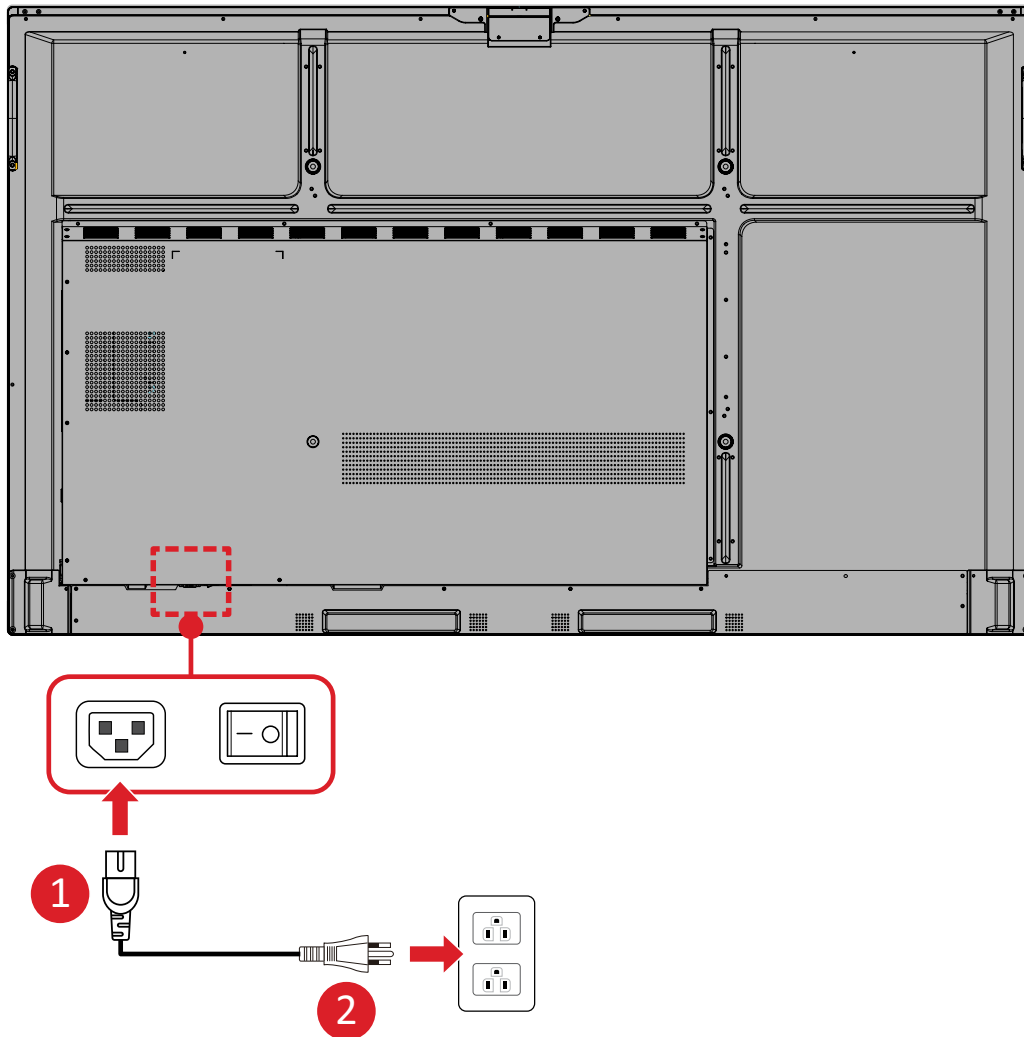

1. Connect the power cord to the **AC IN** jack at the rear of the display.
2. Plug the power cord plug into a power outlet.

Connecting to Video Inputs and Enabling Touch

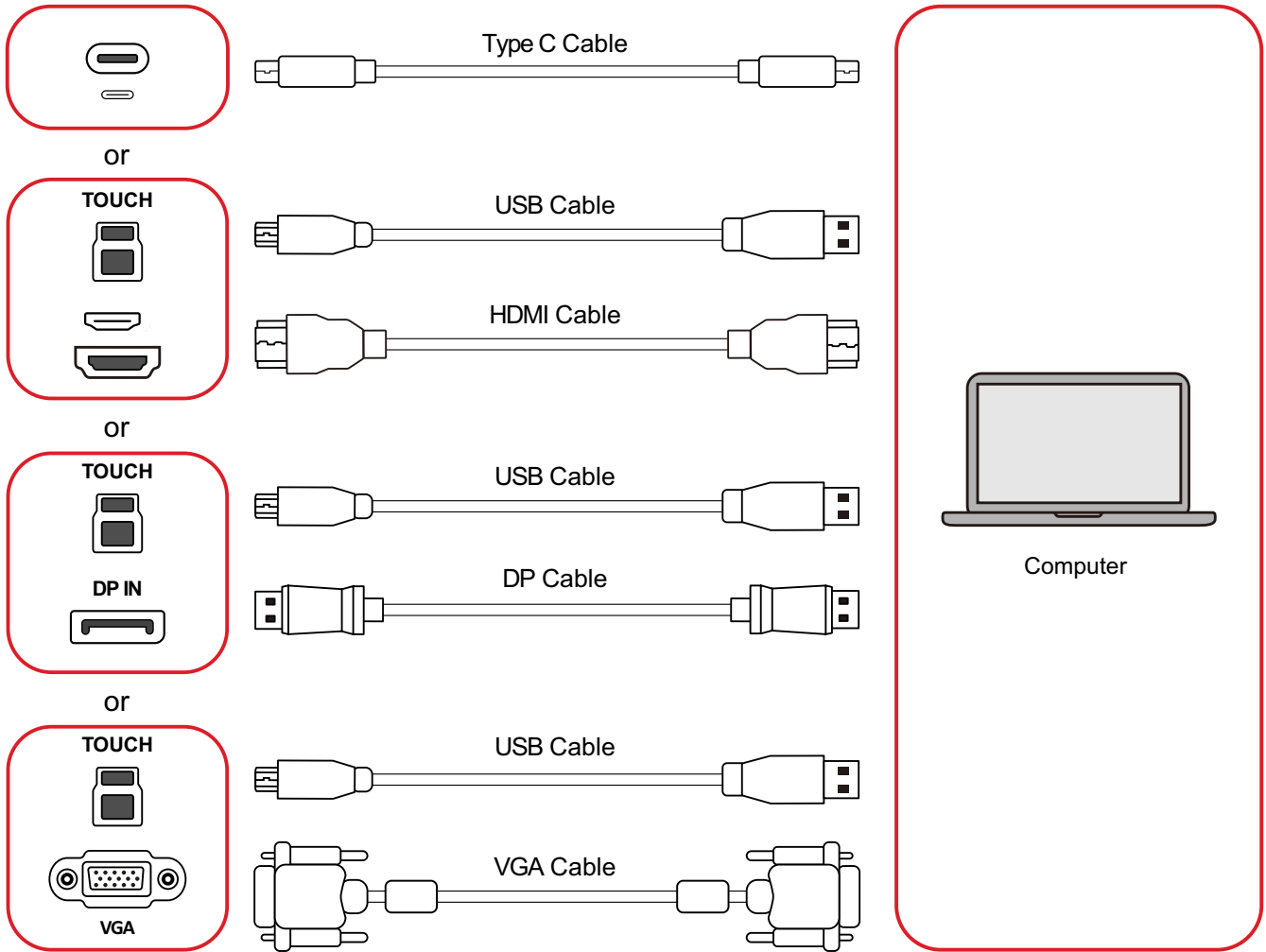

Your external device(s) can be connected in any of the following configurations:

USB Type C Connection

Connect a Type C cable from your external device to a **Type C** port on the ViewBoard.

HDMI Connection

1. Connect an HDMI cable from your external device to the **HDMI 1/2/3/4** port on the ViewBoard.
2. Connect a USB Type B to USB Type A cable to the external device from the appropriate **TOUCH** port of the ViewBoard.

NOTE:

- The **TOUCH 1** port is for the **HDMI 1/HDMI 2/DP/VGA** port.
- The **TOUCH 2** port is for the **HDMI 3/4** port.

DisplayPort Connection

1. Connect a DisplayPort cable from your external device to the **DP** port on the ViewBoard.
2. Connect a USB Type B to USB Type A cable to the external device from the appropriate **TOUCH** port of the ViewBoard.

NOTE:

- The **TOUCH 1** port is for the **HDMI 1/HDMI 2/DP/VGA** port.
- The **TOUCH 2** port is for the **HDMI 3/4** port.

VGA Connection

1. Connect a VGA cable from your external device to the **VGA** port on the ViewBoard.
2. Connect a USB Type B to USB Type A to the external device from the appropriate **TOUCH** port of the ViewBoard.

NOTE:

- The **TOUCH 1** port is for the **HDMI 1/HDMI 2/DP/VGA** port.
- The **TOUCH 2** port is for the **HDMI 3/4** port.

RS-232 Connection



When you use a RS-232 serial cable to connect the ViewBoard to an external computer or control system, certain functions can be controlled remotely such as: power on and off, volume adjustment, input select, brightness, and more.

USB and Network Connections

Just like any PC, it is easy to connect various USB devices and other peripherals to your ViewBoard.

USB Type A

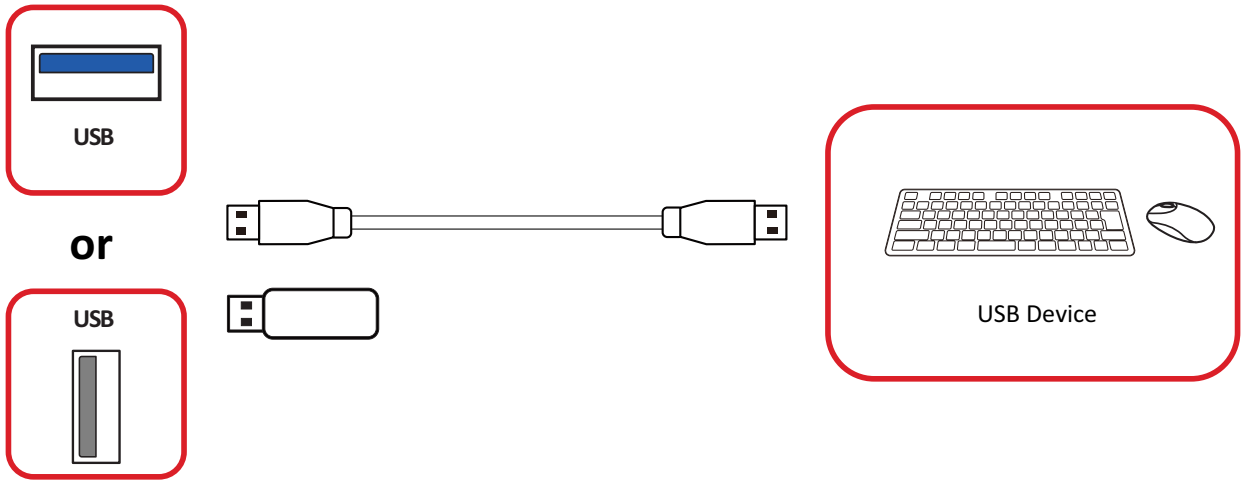

Plug the USB device or storage drive into a **USB Type A** port at the front or side of the ViewBoard.

Network and Modem



To connect to a local network, connect an Ethernet cable to your network, then connect the other end to a **LAN** port on the ViewBoard.

Media Connection

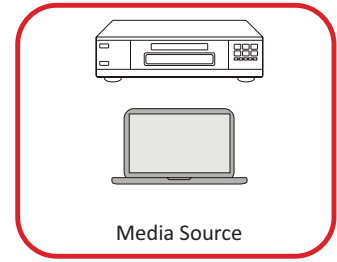
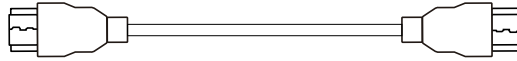
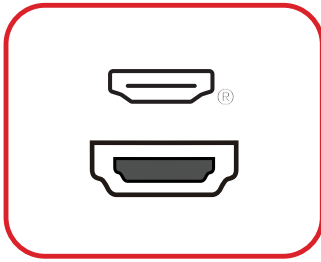

1. Connect an HDMI cable to a **HDMI** port on your ViewBoard and peripheral device.
2. Plug in the power cord of your ViewBoard, and turn on the Power Supply Switch.
3. Press the **Power**  button on the ViewBoard to turn the screen on.
4. Press the **INPUT** button on the remote control and switch to the HDMI input source.

Audio Connection

The ViewBoard supports **Audio In**, **Audio Out**, and **SPDIF**.

Audio In

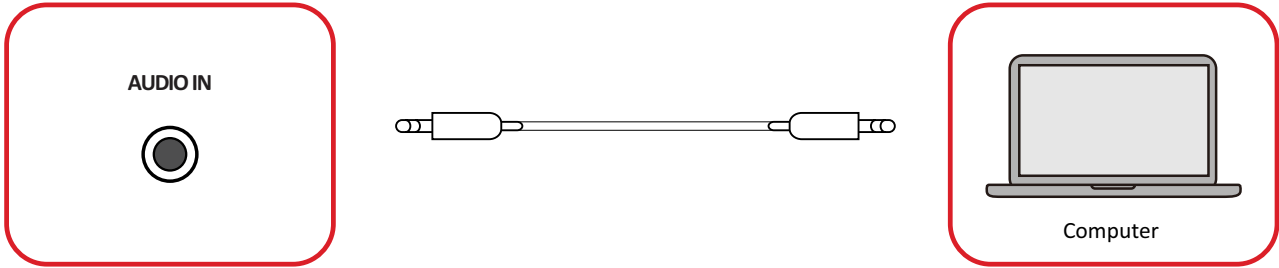

To play audio from your external device through the ViewBoard's speakers, connect one end of an audio cable to your external device, and the other end to the ViewBoard's **AUDIO IN** port.

Audio Out

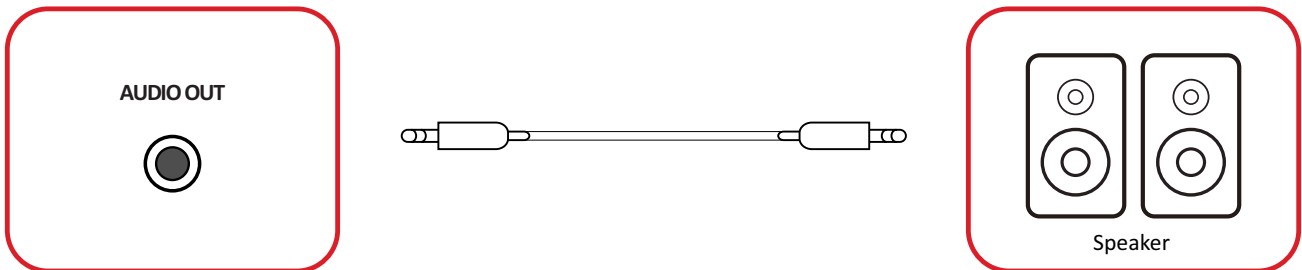

To play audio from the ViewBoard through an external speaker, connect one end of an audio cable to the external speaker, and the other end to the ViewBoard's **AUDIO OUT** port.

SPDIF Connection

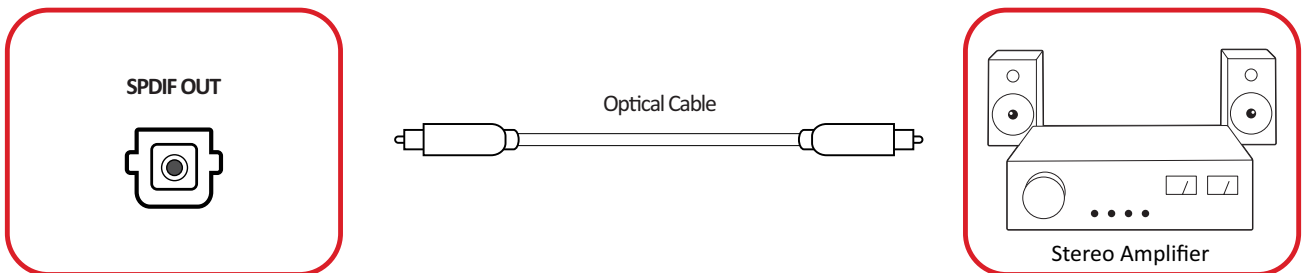

To connect to an external sound system:

1. Connect an optical cable from the **SPDIF** port to your sound system's optical connector.
2. Plug in the power cord of your ViewBoard, and turn on the Power Supply Switch.
3. Press the **Power**  button on the ViewBoard to turn the screen on.

Video Output Connection

HDMI Out



To output video via a display device:

1. Connect an HDMI cable to the **HDMI IN** port of your display device, and the other end to the **HDMI OUT** port of the ViewBoard.
2. Plug in the power cord of the ViewBoard, and turn on the Power Supply Switch.
3. Press the **Power**  button on the ViewBoard to turn the screen on.
4. Press the **INPUT** button on the remote control and switch to the HDMI IN input source.

Optional Connections

NOTE: The following illustrations are for instructional purpose only. For details, please refer to the actual device.

The ViewBoard comes with an **OPS Slot** as well as a **Wi-Fi Slot** for optional add-ons such as a slot-in PC (e.g., VPC-35) or Wi-Fi card (e.g., VB-WIFI-005).

Slot-in PC (OPS Slot) Installation

1. Remove the **OPS Slot** cover of the ViewBoard.

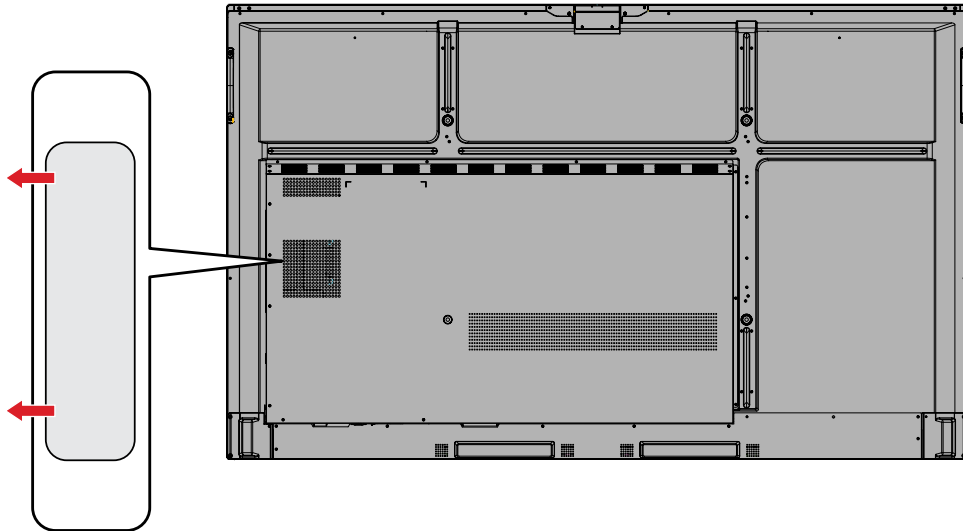

2. Carefully insert the slot-in PC into the **OPS Slot** of the ViewBoard.

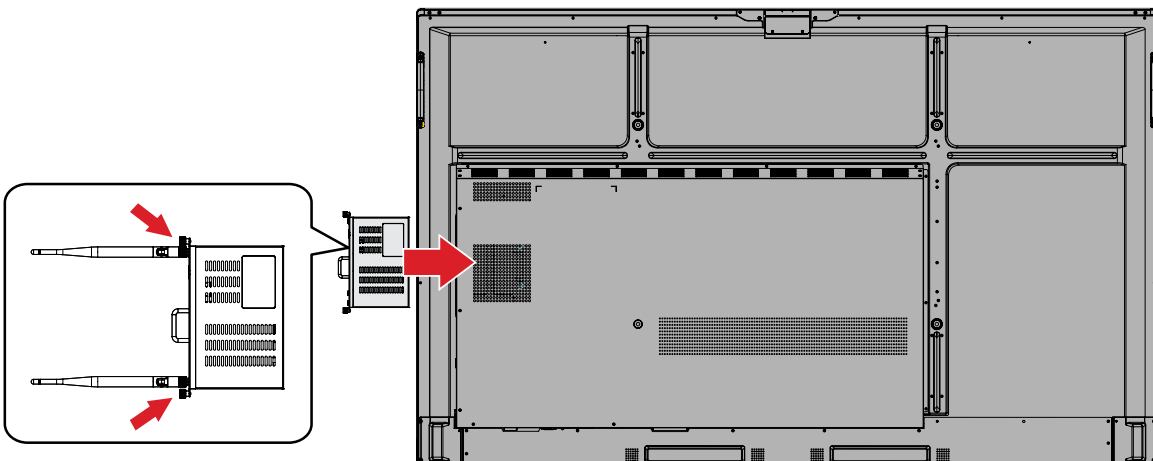

3. Secure the slot-in PC to the ViewBoard.

Wi-Fi Card (Wi-Fi Slot) Installation

1. Remove the **Wi-Fi Slot** cover of the ViewBoard.

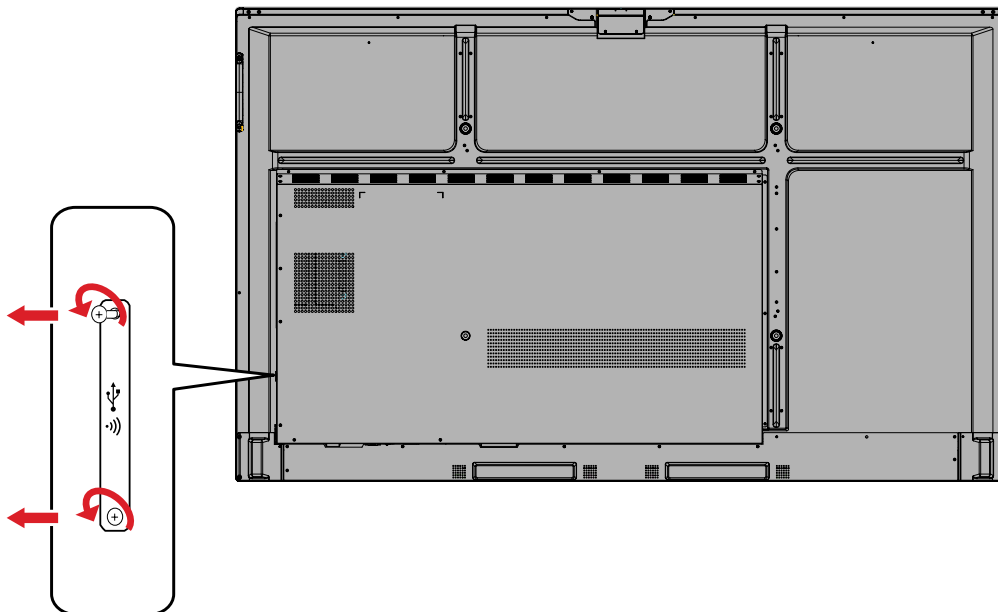

2. Carefully insert the slot-in Wi-Fi card into the **Wi-Fi Slot** of the ViewBoard.

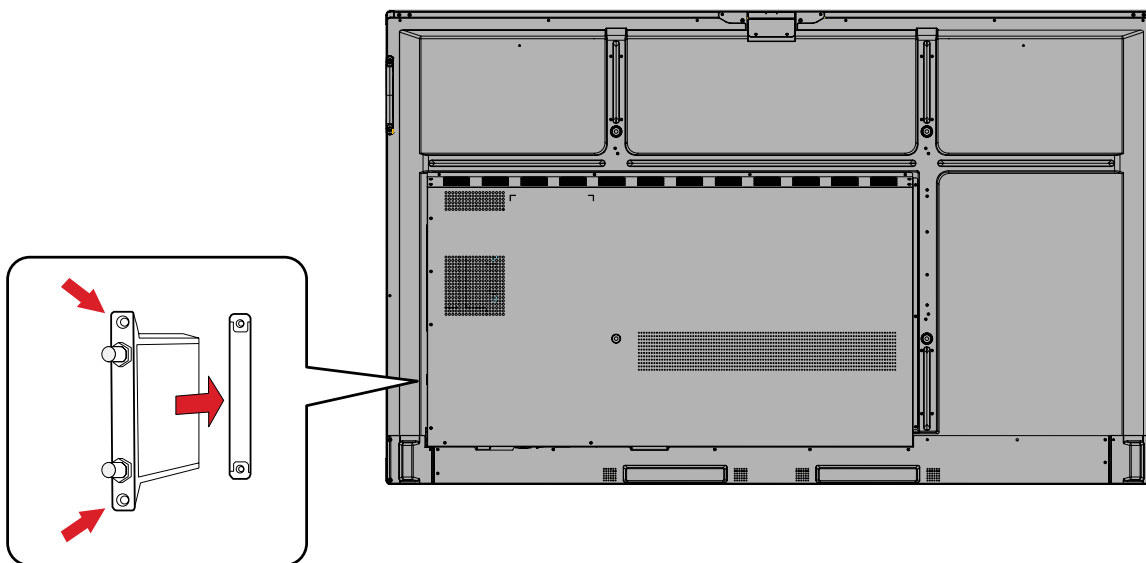

3. Secure the slot-in Wi-Fi card to the ViewBoard.

Using Your ViewBoard

Turning On/Off the ViewBoard

1. Make sure the power cord is connected, plugged into a power outlet, and the Power Supply Switch is in the “on” position.

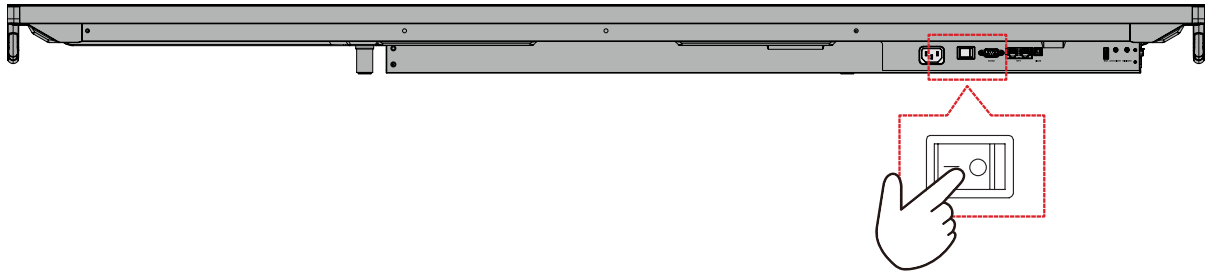

2. Press the **Power** ⏻ button to turn on the ViewBoard.

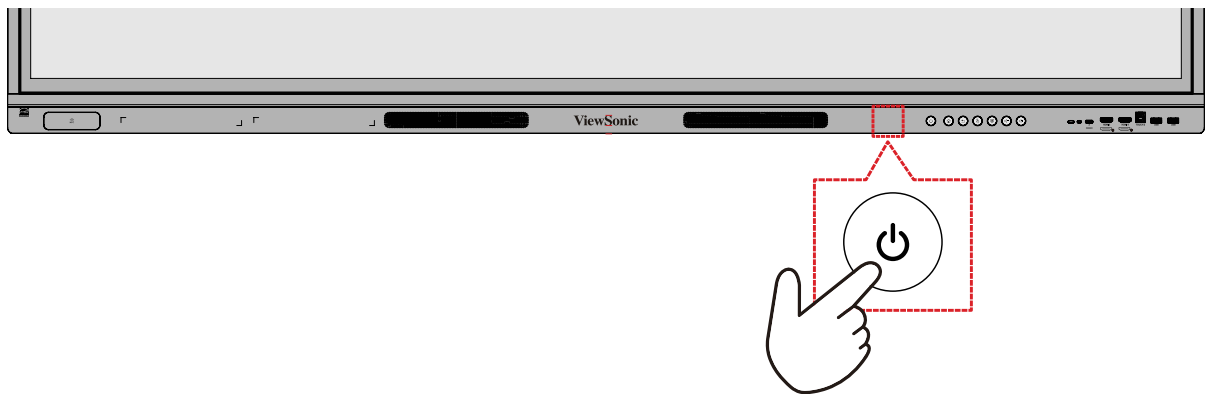

3. To turn the ViewBoard off, press and hold the **Power** ⏻ button.

Initial Launch Setup

When you first turn on your ViewBoard, an initial setup wizard will launch.

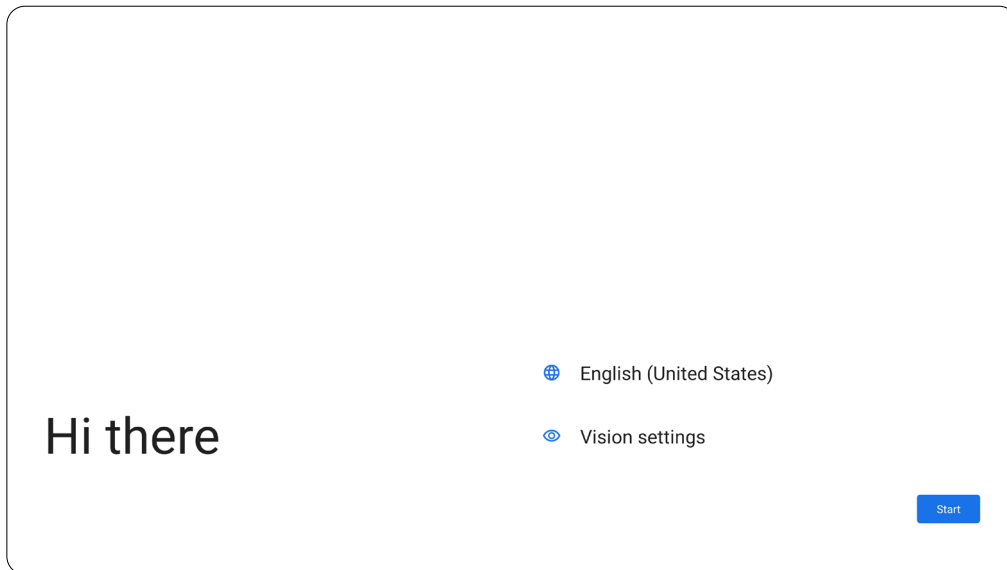

1. Choose your preferred Language.

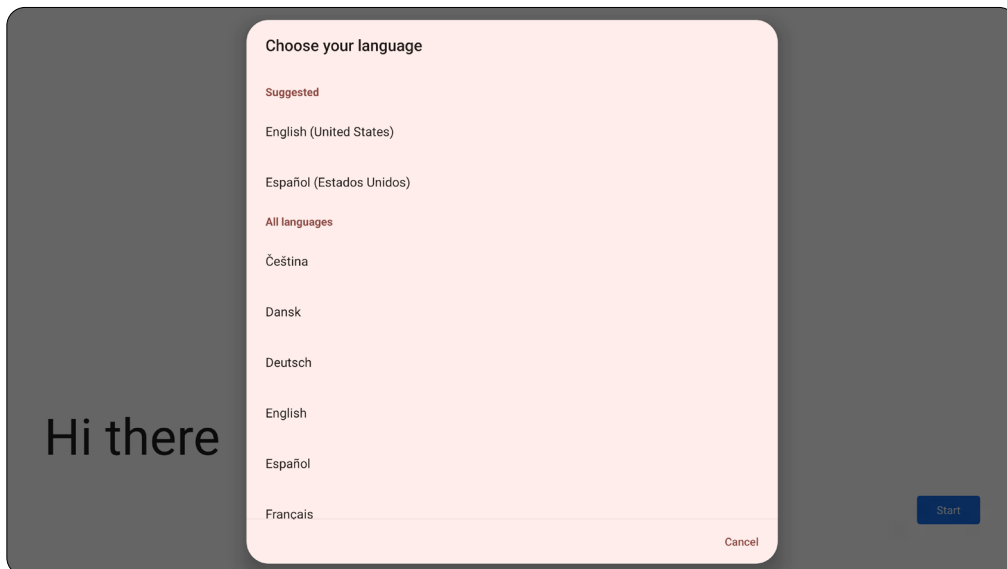

2. Adjust accessibility features as needed.

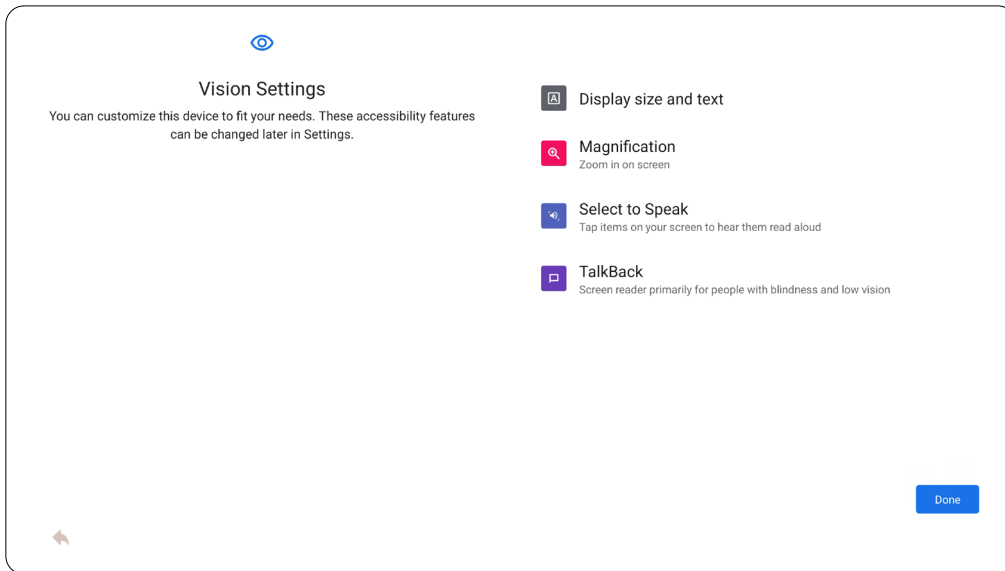

3. Setup and connect to a network.

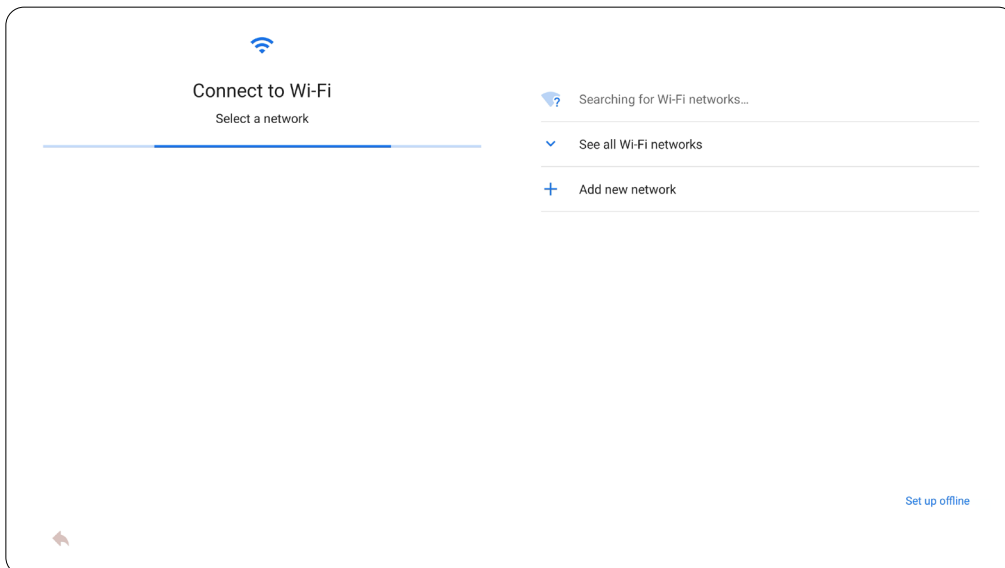

4. Set and adjust the Date and Time as needed.

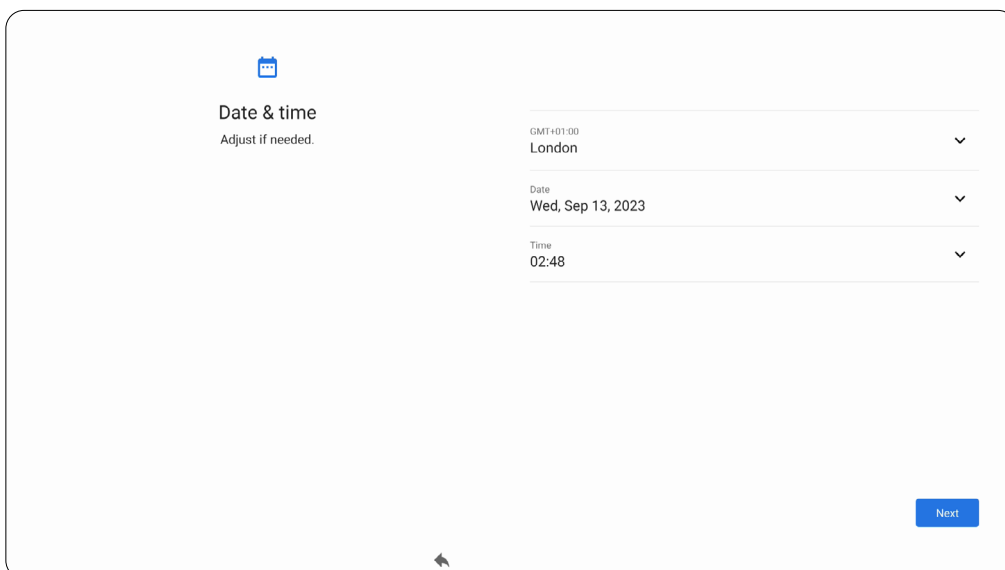

5. Copy your apps and data from another device to the ViewBoard.

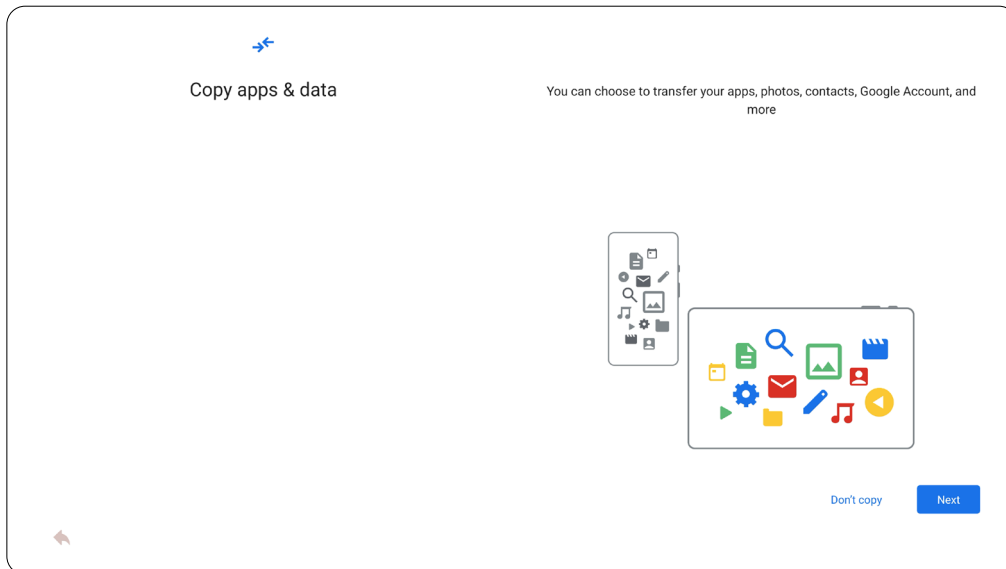

- If you want a fresh start, tap **Don't copy**.
- To start copying and transferring your apps and data, tap **Next**.
 - » If you use a USB cable to copy and transfer data, connect the cable to your devices and follow the on-screen directions to start transfer.
 - » If you don't have a cable, tap **No cable?** to start transfer wirelessly.

NOTE: Before starting, make sure your another device is connected to power, turned on, and unlocked.

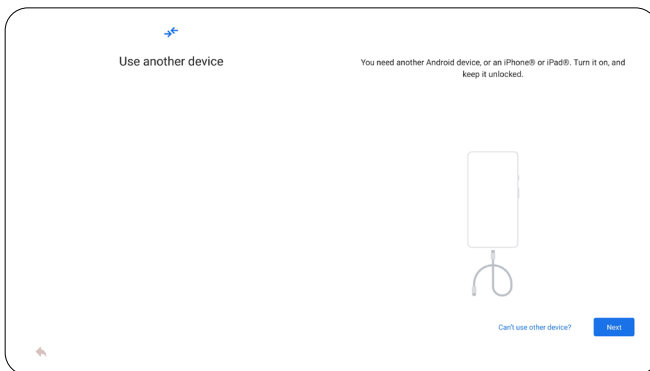

Transferring data with a USB cable

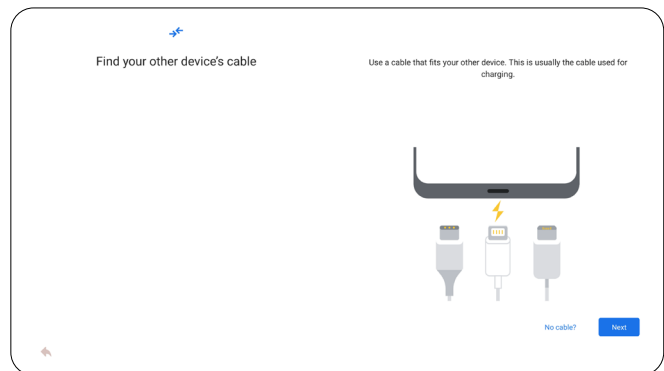

Transferring data wirelessly

6. Sign in with a Google account, or tap **Skip** to continue without signing in.

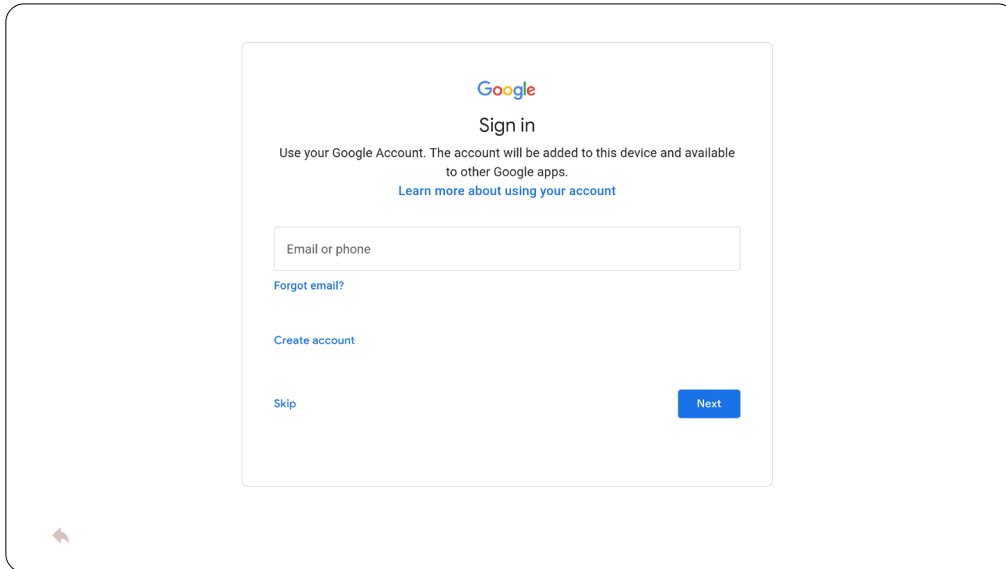

7. Accept or decline the Google services.

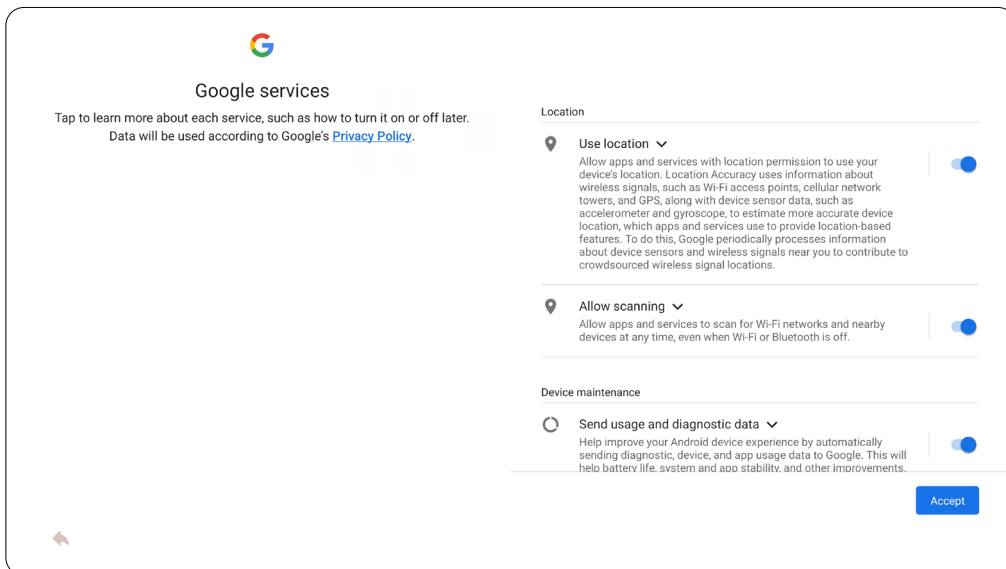

8. Set a PIN to setup a Screen lock. Then, tap **Next**, enter the PIN again, and tap **Confirm**.

NOTE: Personal Identification Number (PIN) helps prevent unauthorized use of the ViewBoard. It is strongly recommended to set a pin for each of the owner profiles as only owners can manage access to the ViewBoard(s) and more.

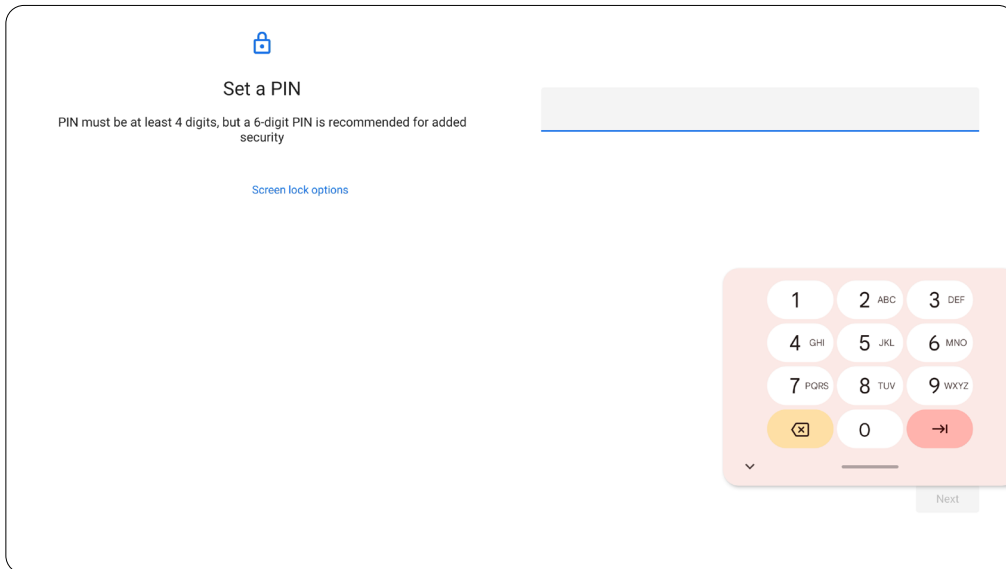

9. Select **Enable Device Owner Permissions** to confirm the ownership and gain access to the advanced features on myViewBoard Manager. Then, tap **Next**.

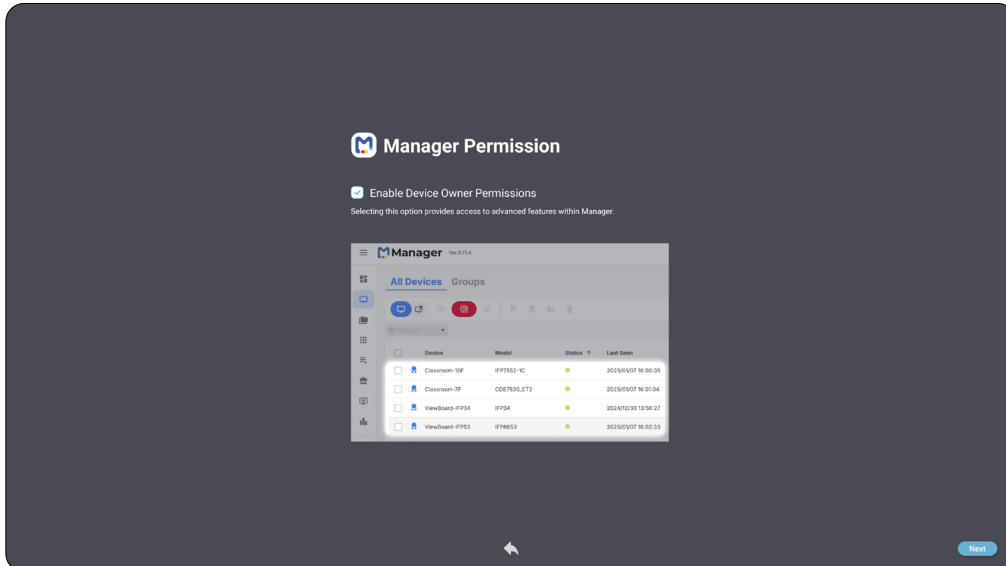

10. Select the preferred boot up mode, then tap **Next**.

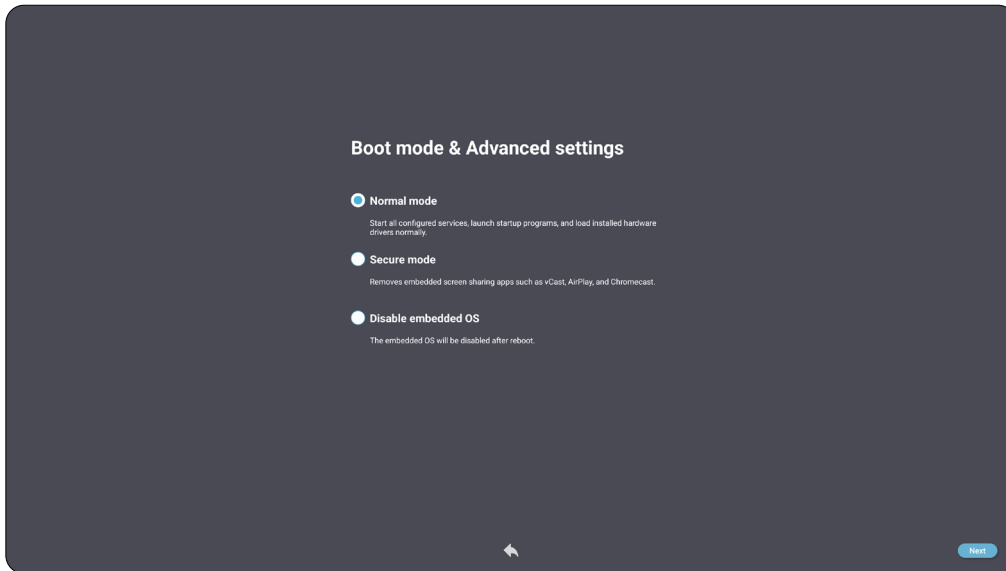

11. Select the preferred Operating System (OS) launcher.

- Select **Enable ViewBoard Launcher** for the ViewBoard launcher scheme.
- Deselect **Enable ViewBoard Launcher** for the Android launcher scheme.

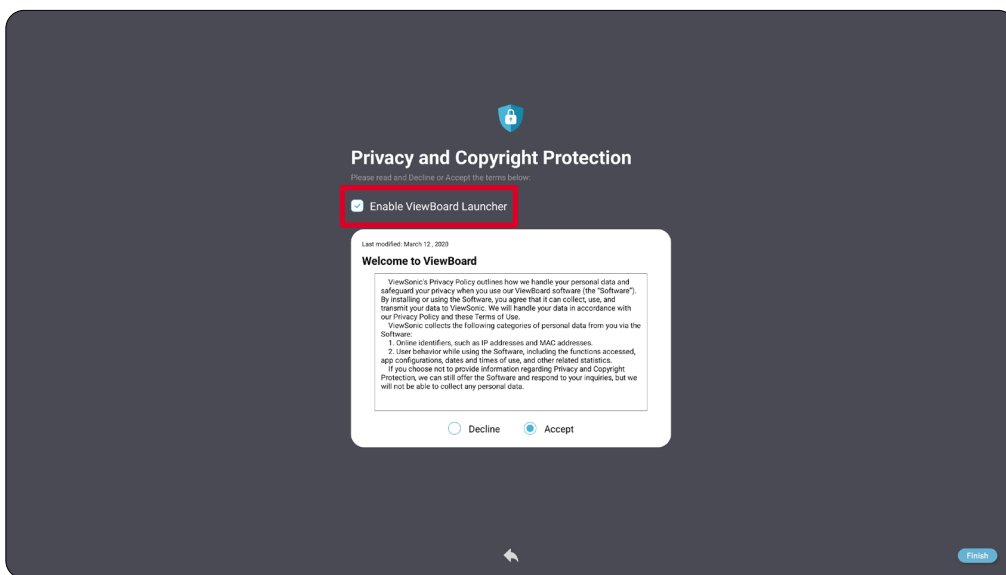

NOTE: You can always switch to the other launcher scheme later in the **System** settings. Go to “ViewBoard Settings” for more details.

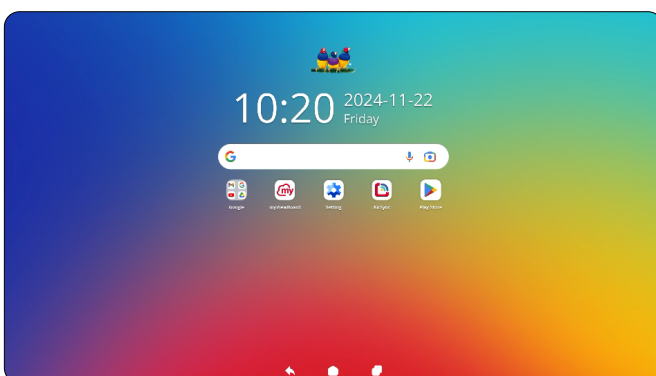

Android Launcher (Scheme A)

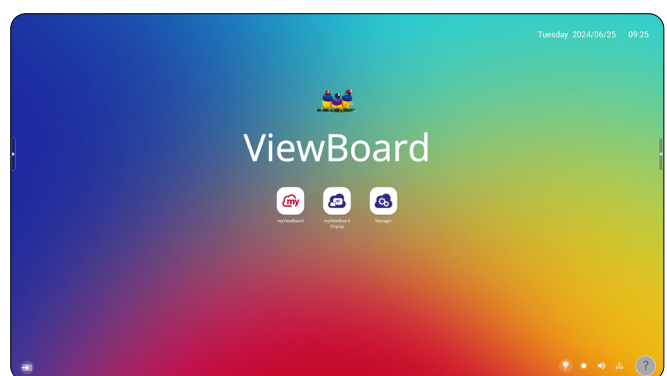

ViewBoard Launcher (Scheme B)

12. Accept or decline the Privacy and Copyright Protection terms. Then, tap **Finish** to complete the initial setup.

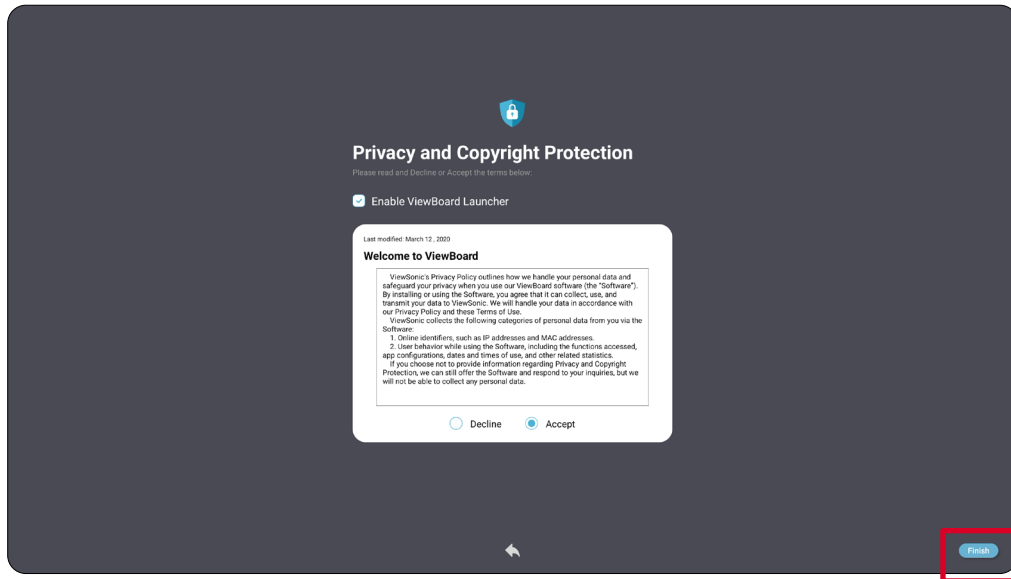

Home Screen

NOTE: The Home Screen layout varies between the two Launchers. Use the following ViewBoard Launcher example as a general reference only.

On the Home Screen select from **Use as Guest** and **Sign In**.

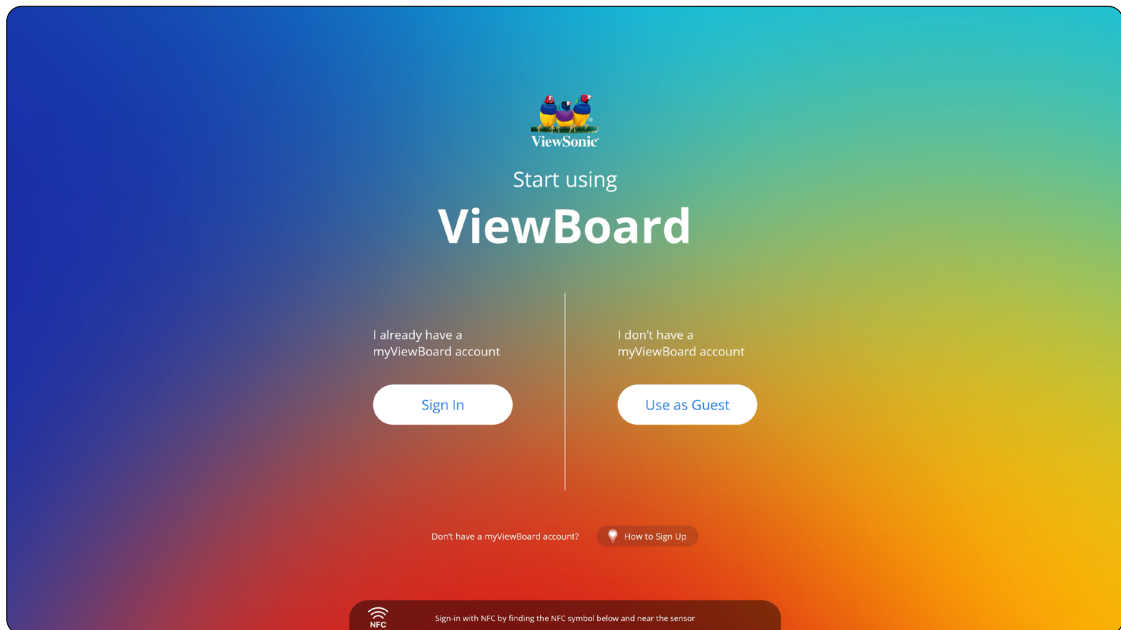

How to Sign Up

Select the **How to Sign Up** button at the bottom of the screen, then scan the QR code and follow the directions to log in.

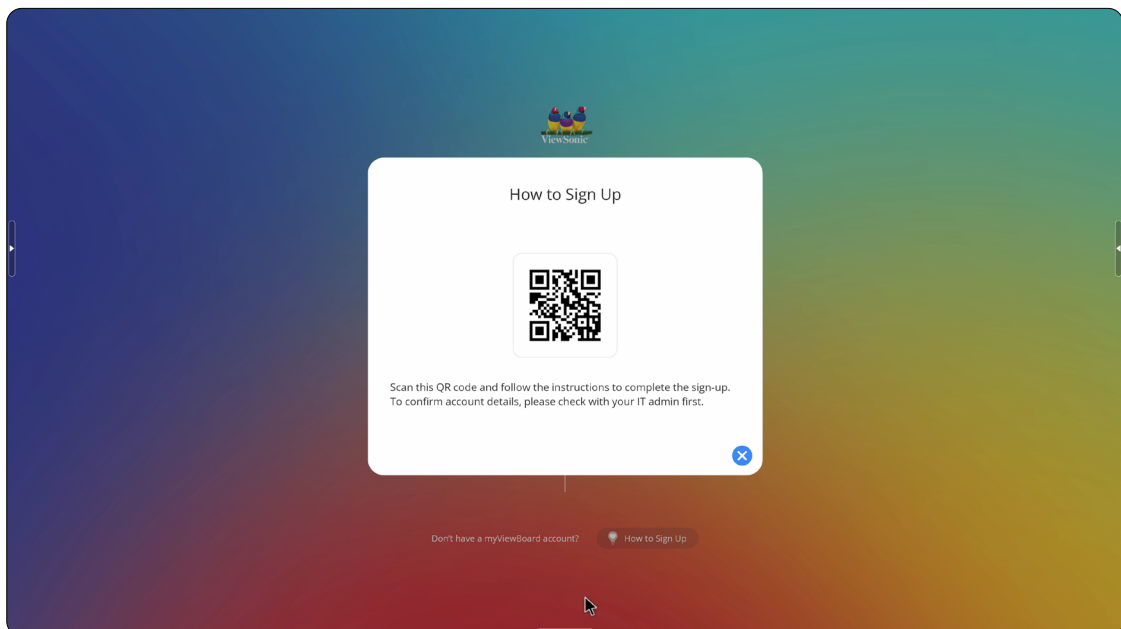

Use as Guest

Select the **Use as Guest** button to log in with a guest account.

NOTE: Please note that user settings cannot be saved when logging in with a guest account.

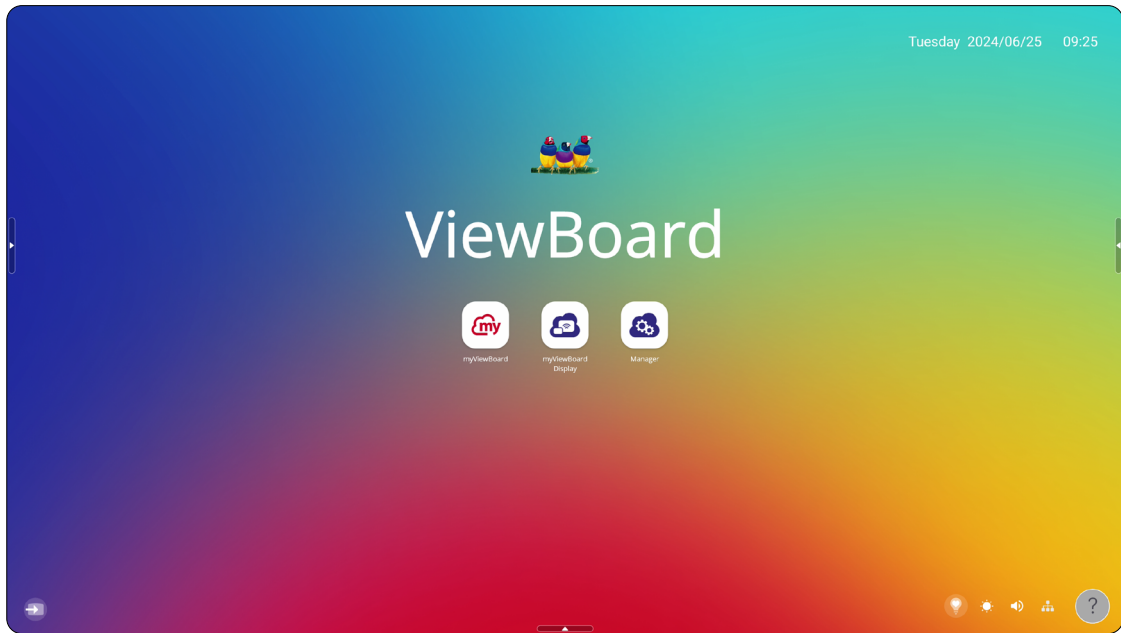

Sign In

Select the **Sign In** button to log in with various accounts.

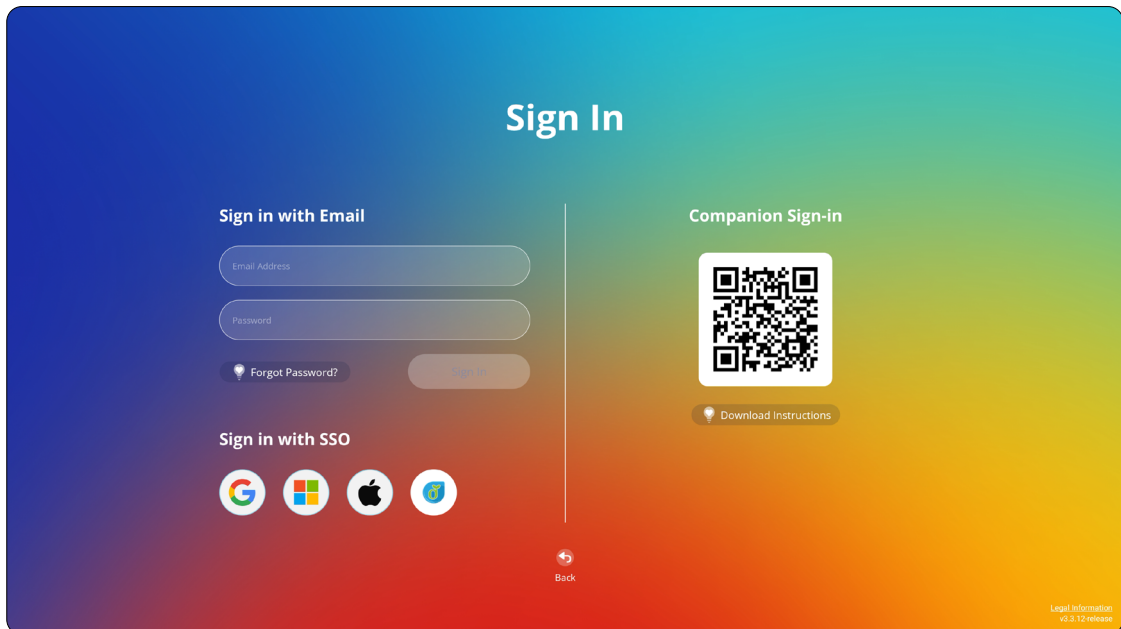

Home Screen Message

The Home Screen message can be edited by selecting it directly on the Home Screen.

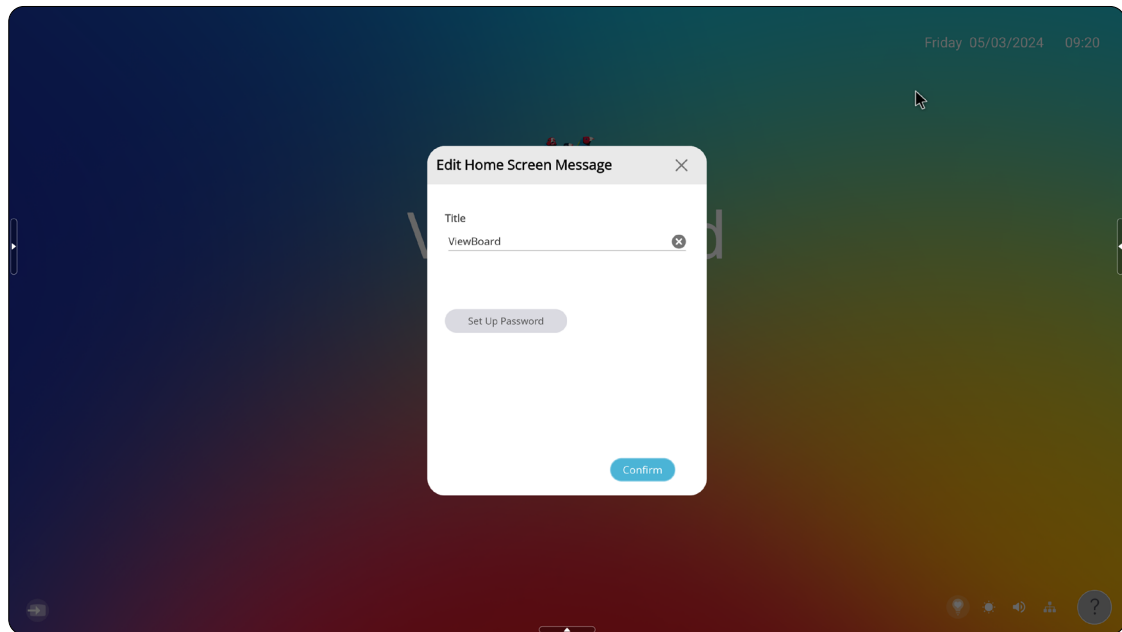

Additionally, a password can be set by selecting the **Set Up Password** button.

Toolbar

The Toolbar is where applications and tools can be found. Trigger icons are on the right, left, and bottom edge of the screen for quick access.

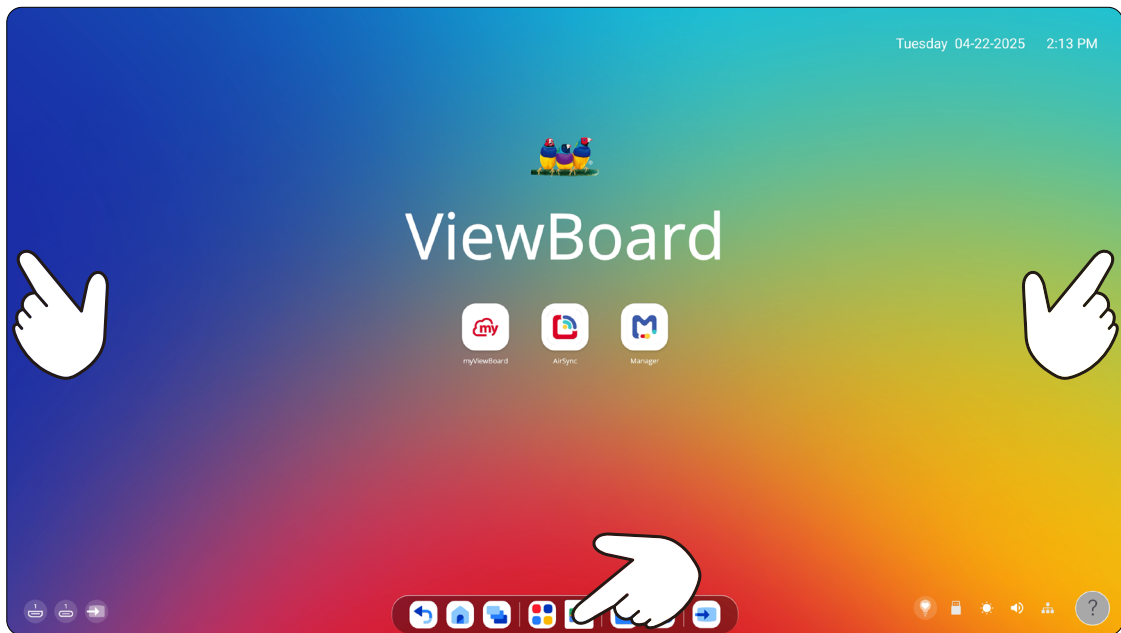



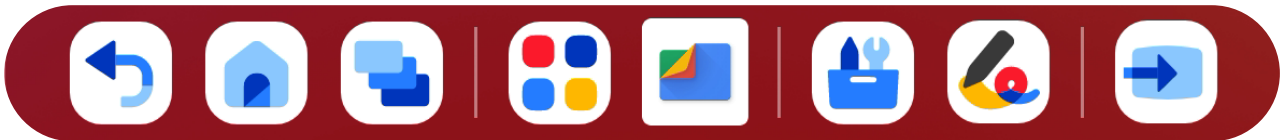

To launch an application or tool:



1. Tap a Toolbar trigger icon.
2. Tap on your desired application or tool.

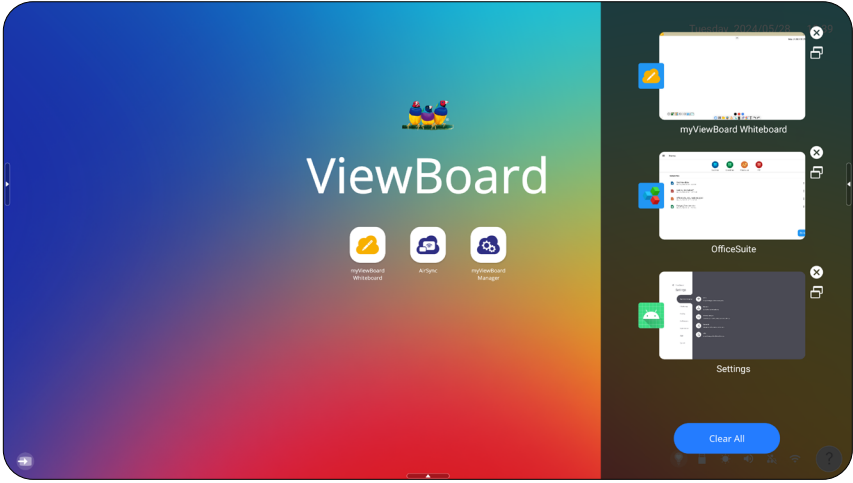
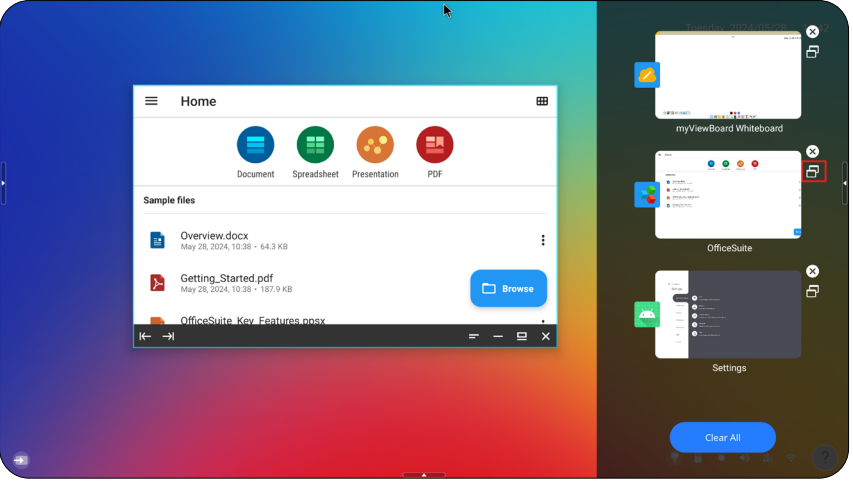

NOTE: The default Toolbar setting is to be available for all input sources; however, users can go to: **Settings > Preference > Toolbar settings** to adjust the options: (1) Show side Toolbar, (2) Hide side toolbar, (3) Disable in all input sources.

Toolbar Icons

Icon	Description
 <p>Return</p>	<p>Return to the previous operation screen.</p> <p>NOTE: Only for the ViewBoard source.</p>
 <p>Home</p>	<p>Return to the Home Screen.</p>
 <p>Recent</p>	<p>Display all currently open applications.</p>  <p>Select the small frame to display in a PIP window.</p>  <p>NOTE: Selecting the “X” will close the application.</p>
 <p>Applications</p>	<p>View all installed applications.</p>
 <p>File Folder</p>	<p>Browse and open files.</p>

Icon	Description
 Tools	<p>Quickly view and adjust various frequently used tools.</p>
 Marker	<p>Annotate with underlying, highlighting, and more. NOTE: Pick up the Touch Pen to turn on Marker.</p>
 Input Source	<p>Select and change the input source signal.</p>

On-Screen Display (OSD) Menu - General Settings

Access **Input**, **Display**, and other general settings through the OSD Menu.

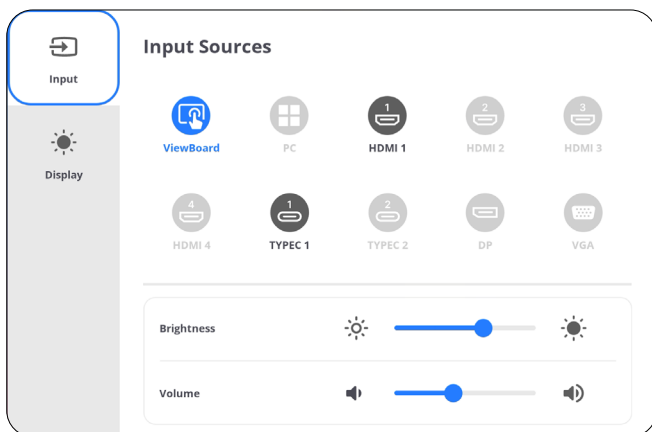

Input Settings

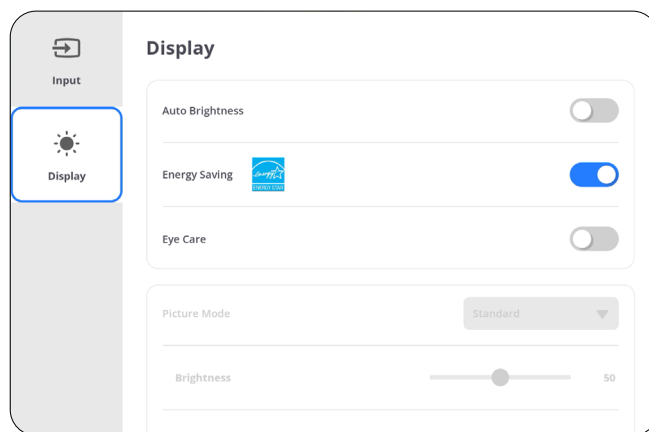

Display Settings

Open the OSD Menu by pressing **INPUT** on the remote control or tapping the **Input Source** icon (➡).

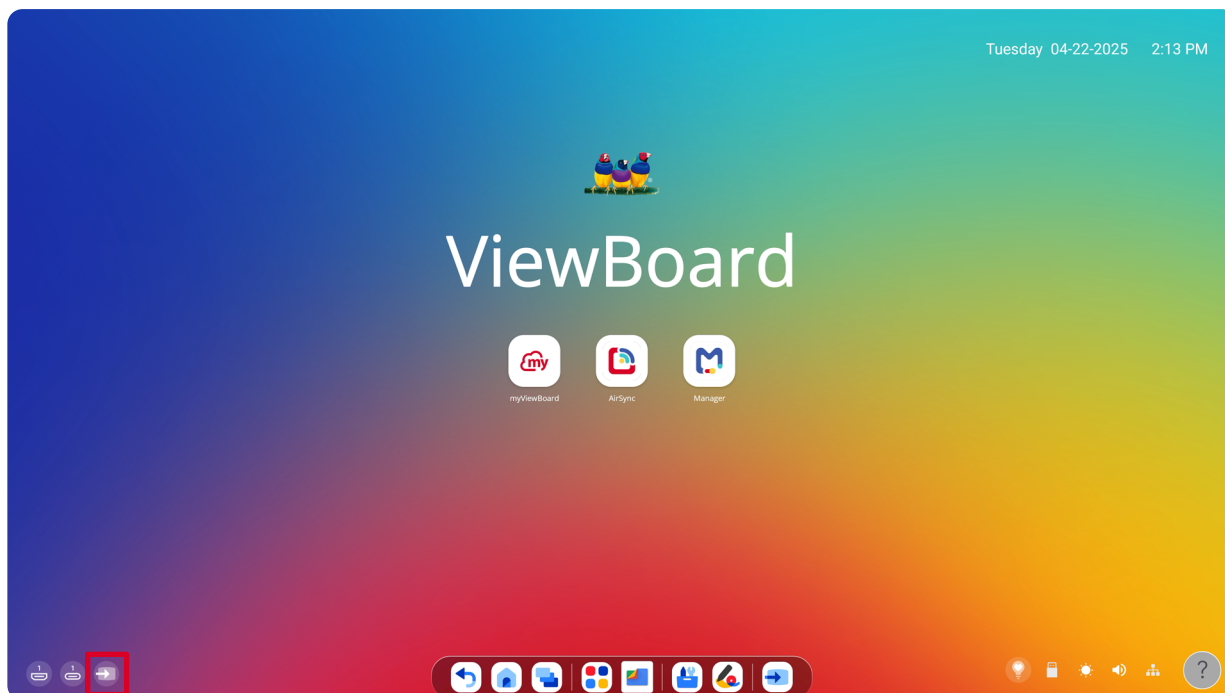

The **Input Sources** setting can also display by tapping the signal source icon.

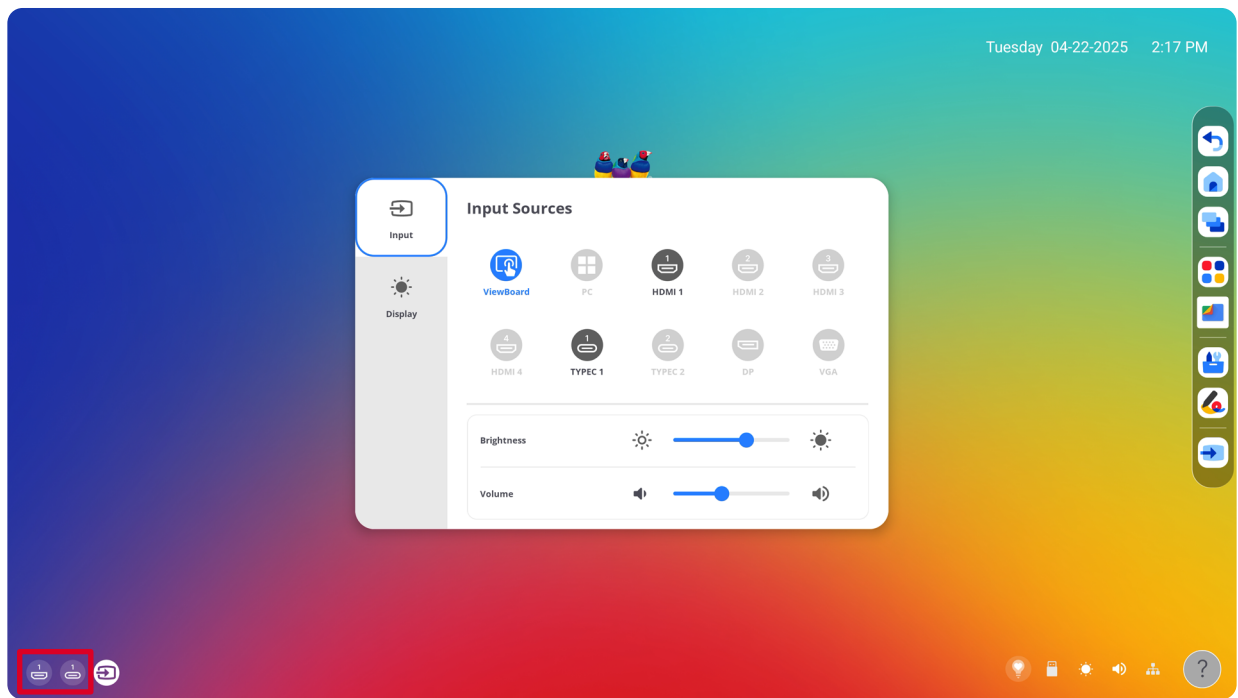

Input Settings

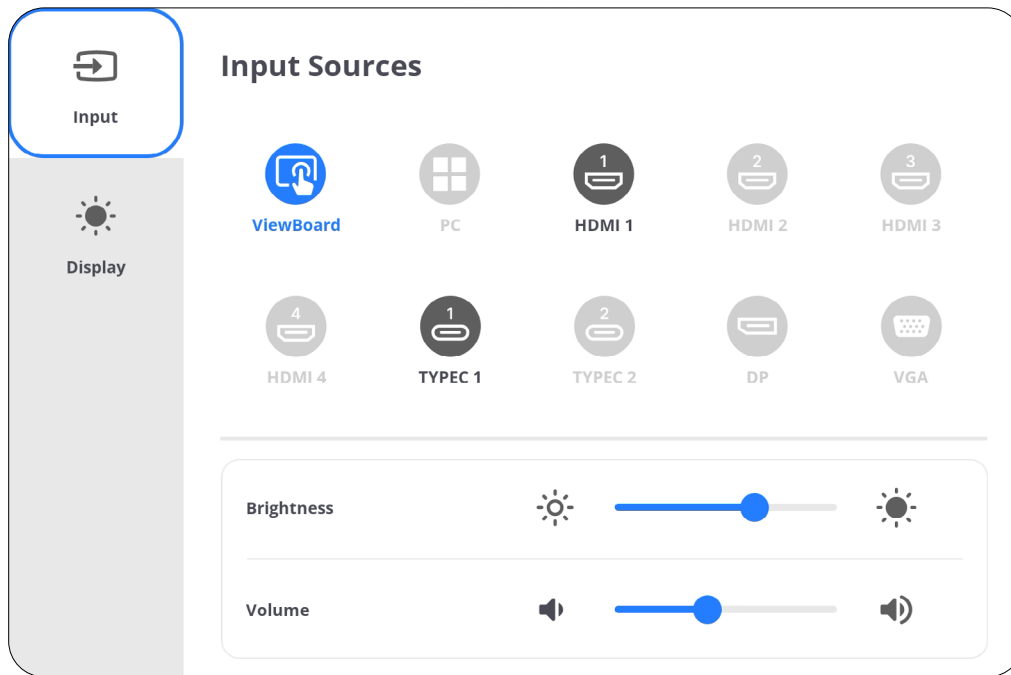

To select an input source:

1. Press **INPUT** on the remote control or tap the **Input Source** icon (➡) to display the **Input Settings** menu.

2. Press ▲/▼/◀/▶ on the remote control to select the input source you want.

NOTE: The PC source will only be visible when a slot-in computer is installed.

3. Press **ENTER** on the remote control, or tap the desired input source.

4. Press **BACK** (⏪) on the remote control, or tap a blank area outside of the menu to exit.

To adjust the brightness:

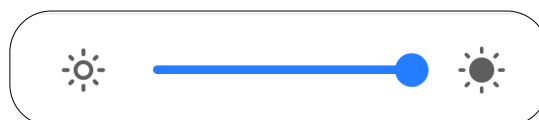

1. Press **INPUT** on the remote control or tap the **Input Source** icon (➡) to display the **Input Settings** menu.

2. Drag the brightness slider directly to adjust the backlight value.

3. Press **BACK** (⏪) on the remote control, or tap a blank area outside of the menu to exit.

To adjust the volume:

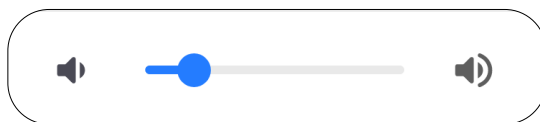

1. Press **INPUT** on the remote control or tap the **Input Source** icon (➡) to display the **Input Settings** menu.
2. Drag the volume slider directly to adjust the value, or press (🔊) +/- on the remote control to adjust. Additionally, pressing **Mute** (🔇) on the remote control will mute/unmute the volume.
3. Press **BACK** (⬅) on the remote control, or tap a blank area outside of the menu to exit.

Display Settings

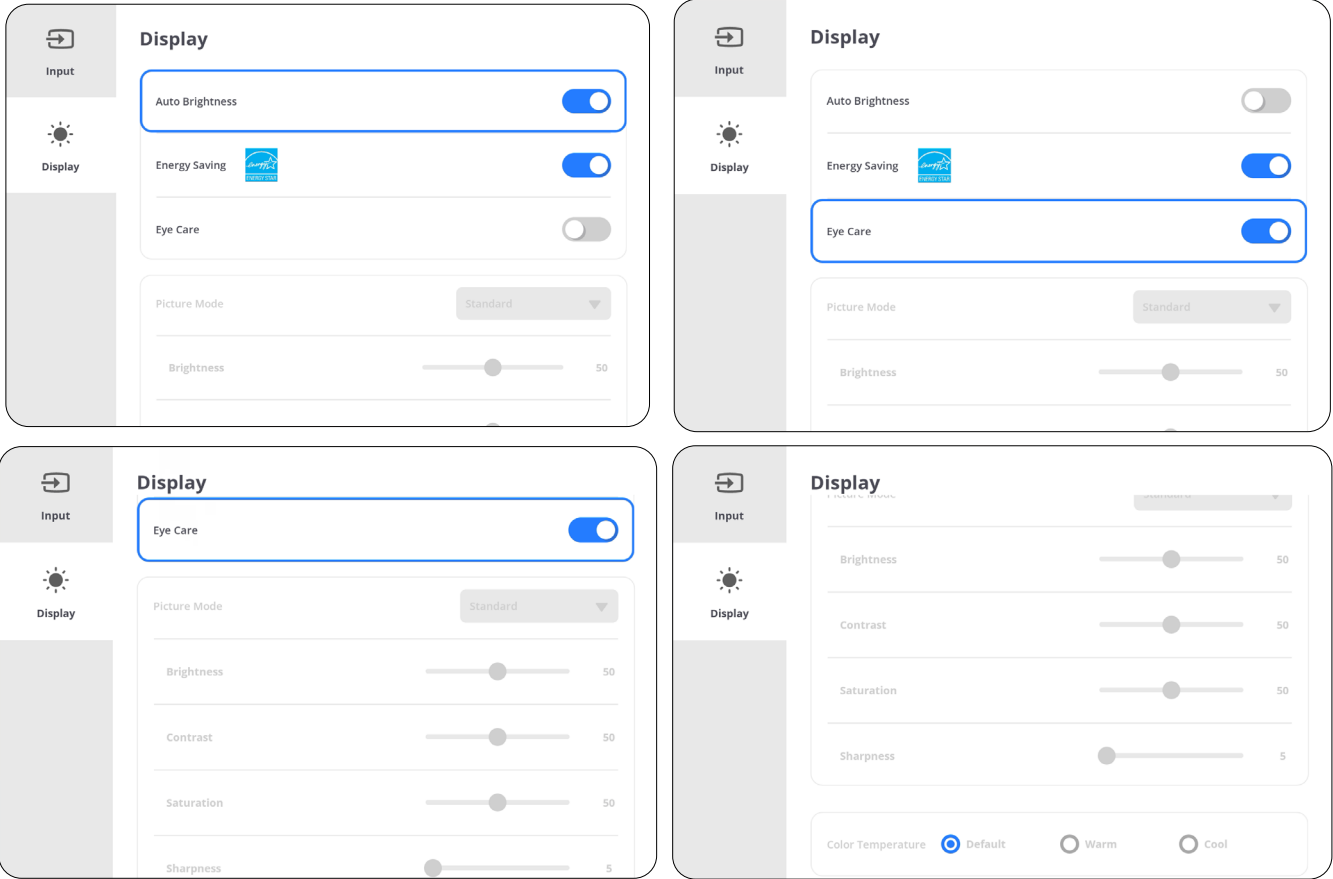

To adjust the display settings:

1. Press **INPUT** on the remote control or tap the **Input Source** icon (➔) to display the **Input Settings** menu. Then select the **Display** tab.
2. Press ▲/▼/◀/▶ on the remote control to select the menu option you want.
3. Press **ENTER** on the remote control to confirm or press ◀/▶ to adjust the menu option. Additionally, tap/adjust the menu option directly.
4. Press **BACK** (⏪) on the remote control, or tap a blank area outside of the menu to exit.

Display Settings - Menu Options

Item	Description										
Auto Brightness	Automatic brightness adjustment. Adjusts maximum brightness according to ambient light levels.										
Energy Saving	Enable to reduce power consumption.										
Eye Care	Adjusts the filter that blocks high-energy blue light for a more comfortable viewing experience.										
Picture Mode	Select a predefined picture setting.										
	<table border="1"> <thead> <tr> <th data-bbox="480 591 691 640">Mode</th> <th data-bbox="691 591 1401 640">Description</th> </tr> </thead> <tbody> <tr> <td data-bbox="480 640 691 689">Standard</td> <td data-bbox="691 640 1401 689">Default picture mode.</td> </tr> <tr> <td data-bbox="480 689 691 815">Bright</td> <td data-bbox="691 689 1401 815">Maximizes the brightness of the display. This mode is suitable for environments where extra-high brightness is required (e.g., well-lit rooms).</td> </tr> <tr> <td data-bbox="480 815 691 864">Soft</td> <td data-bbox="691 815 1401 864">A high brightness level with lower contrast level.</td> </tr> <tr> <td data-bbox="480 864 691 913">Custom</td> <td data-bbox="691 864 1401 913">Customize the picture settings.</td> </tr> </tbody> </table>	Mode	Description	Standard	Default picture mode.	Bright	Maximizes the brightness of the display. This mode is suitable for environments where extra-high brightness is required (e.g., well-lit rooms).	Soft	A high brightness level with lower contrast level.	Custom	Customize the picture settings.
	Mode	Description									
	Standard	Default picture mode.									
	Bright	Maximizes the brightness of the display. This mode is suitable for environments where extra-high brightness is required (e.g., well-lit rooms).									
Soft	A high brightness level with lower contrast level.										
Custom	Customize the picture settings.										
Standard	Default picture mode.										
Bright	Maximizes the brightness of the display. This mode is suitable for environments where extra-high brightness is required (e.g., well-lit rooms).										
Soft	A high brightness level with lower contrast level.										
Custom	Customize the picture settings.										
Brightness	Adjust the background black levels of the screen.										
Contrast	Adjusts the difference between the image background (black level) and the foreground (white level). Use this to set the peak white level after you have previously adjusted the Brightness setting to suit your selected input and viewing environment.										
Saturation	Adjust the amount of color present.										
Sharpness	A high value results in a sharper picture; a low value softens the picture.										
Color Temperature	Adjust the color temperature value.										

Eye Care

Eye Care blocks high-energy blue light for a more comfortable viewing experience.

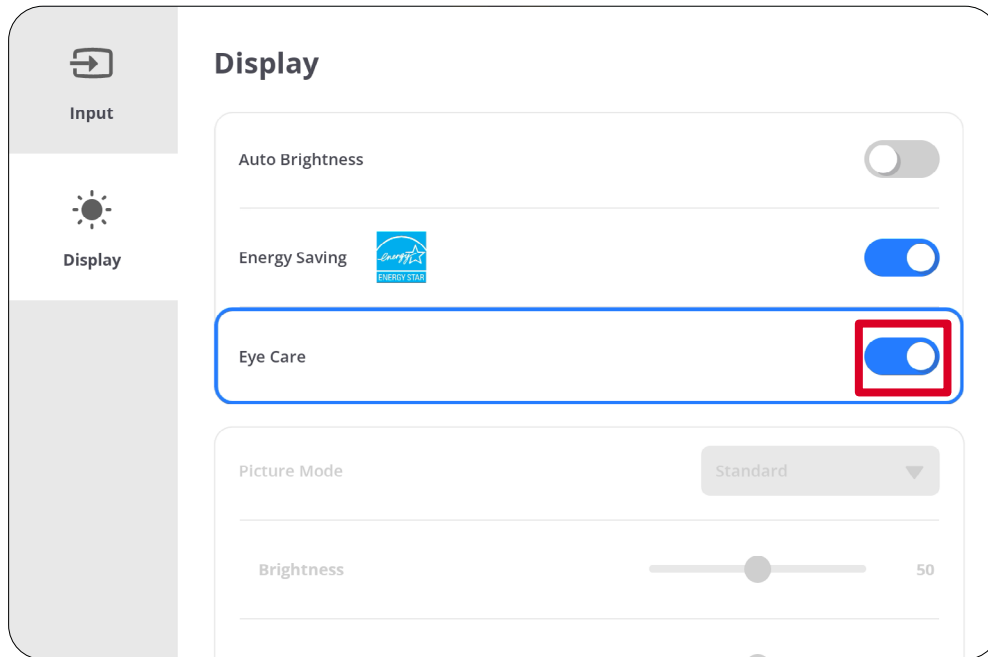

Calculating Breaks

When viewing screens for extended periods, it is recommended to take periodic breaks from viewing. Short breaks of at least 10 minutes are recommended after one hour of continuous viewing.

Taking shorter, more frequent breaks are generally more beneficial than longer, less frequent breaks.

Focus Fatigue (20-20-20 Rule)

To reduce the risk of eye fatigue by constantly looking at the screen, look away from the screen at least every 20 minutes and gaze at a distant object (at least 20 feet away) for at least 20 seconds.

Looking at Distant Objects

While taking breaks, users can further reduce eye strain and dryness by focusing on objects that are further away from them for 10-15 seconds, then gaze at something up close for 10-15 seconds. Repeat this up to 10 times. This exercise reduces the risk of your eyes' focusing ability to "lock up" after prolonged computer work.

Eye and Neck Exercises

Eye Exercises

Eye exercises can help minimize eye strain. Slowly roll your eyes to the left, right, up, and down. Repeat as many times as needed.

Exercises for the eyes

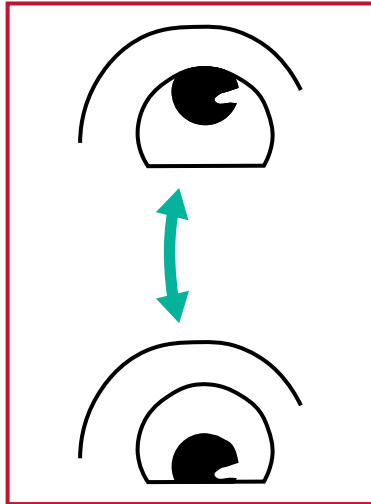

(1) Keep the body and the head upright. Move the eyes up to look at the ceiling, then turn down to look at the floor.

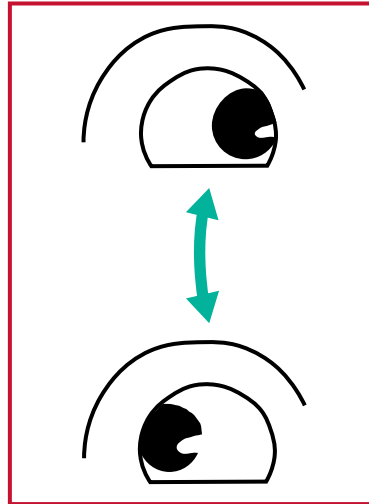

(2) Move the eyes left and right slowly to look at objects on the two sides.

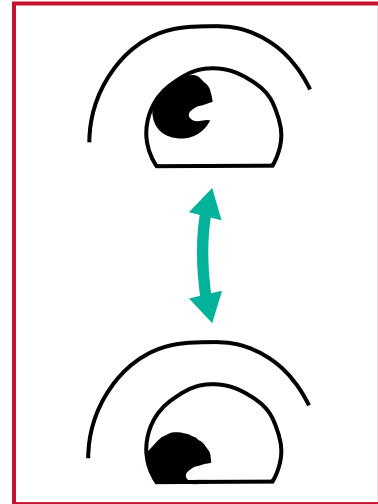

(3) Move the eyes to look at objects at the right upper direction and then right lower direction. Repeat for the left upper and left lower directions.

Neck Exercises

Neck exercises can also help minimize eye strain. Relax your arms and let them hang at your sides, bend forward slightly to stretch the neck, turn your head to the right and to the left. Repeat as many times as needed.



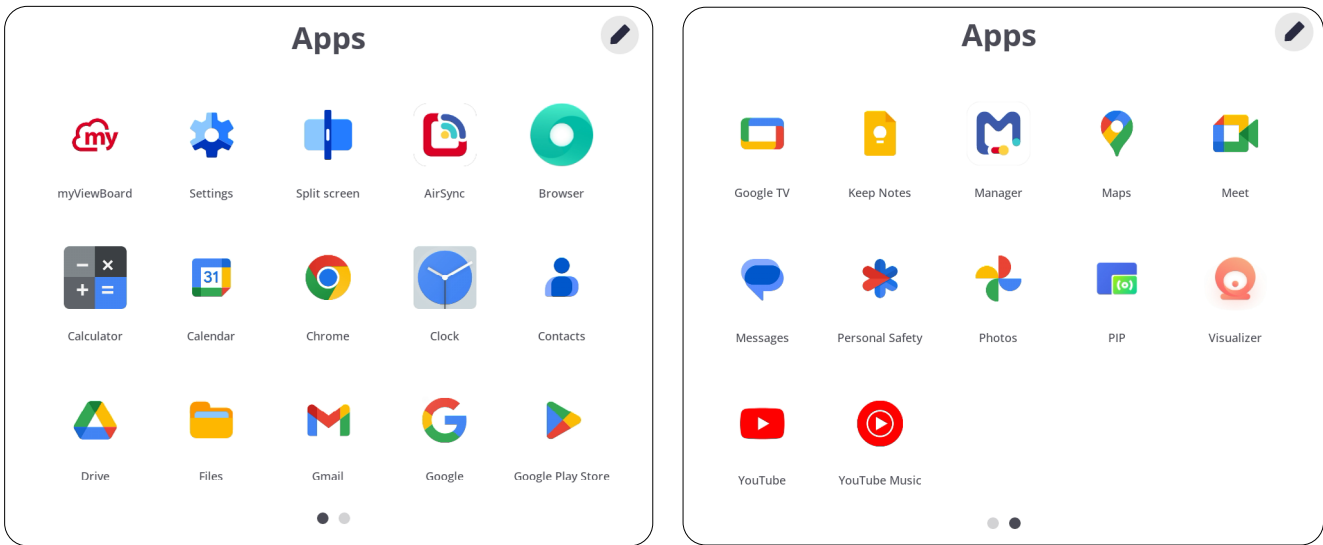

Applications

Much like any smart phone or tablet you can install several different applications.



Applications can be accessed from the Toolbar, directly from the Home Screen via shortcuts, or by selecting the **Applications** icon ().

NOTE: The following included application descriptions are not a comprehensive list and will vary by the user.

Icon	Description
	<p><u>Airsync</u> Wirelessly mirror screens to a larger display.</p>
	<p><u>myViewBoard Manager</u> Remotely manage multiple installations of ViewSonic devices.</p>
	<p><u>myViewBoard Whiteboard</u> A digital whiteboarding application.</p>
	<p><u>Settings</u> Access the System Settings.</p>

ViewBoard Settings

ViewBoard Launcher

Wireless & Network

Check current network connection status, set up and manage **Wi-Fi**, **Ethernet**, **Bluetooth**, and **VPN**, and establish a **Wireless hotspot**.

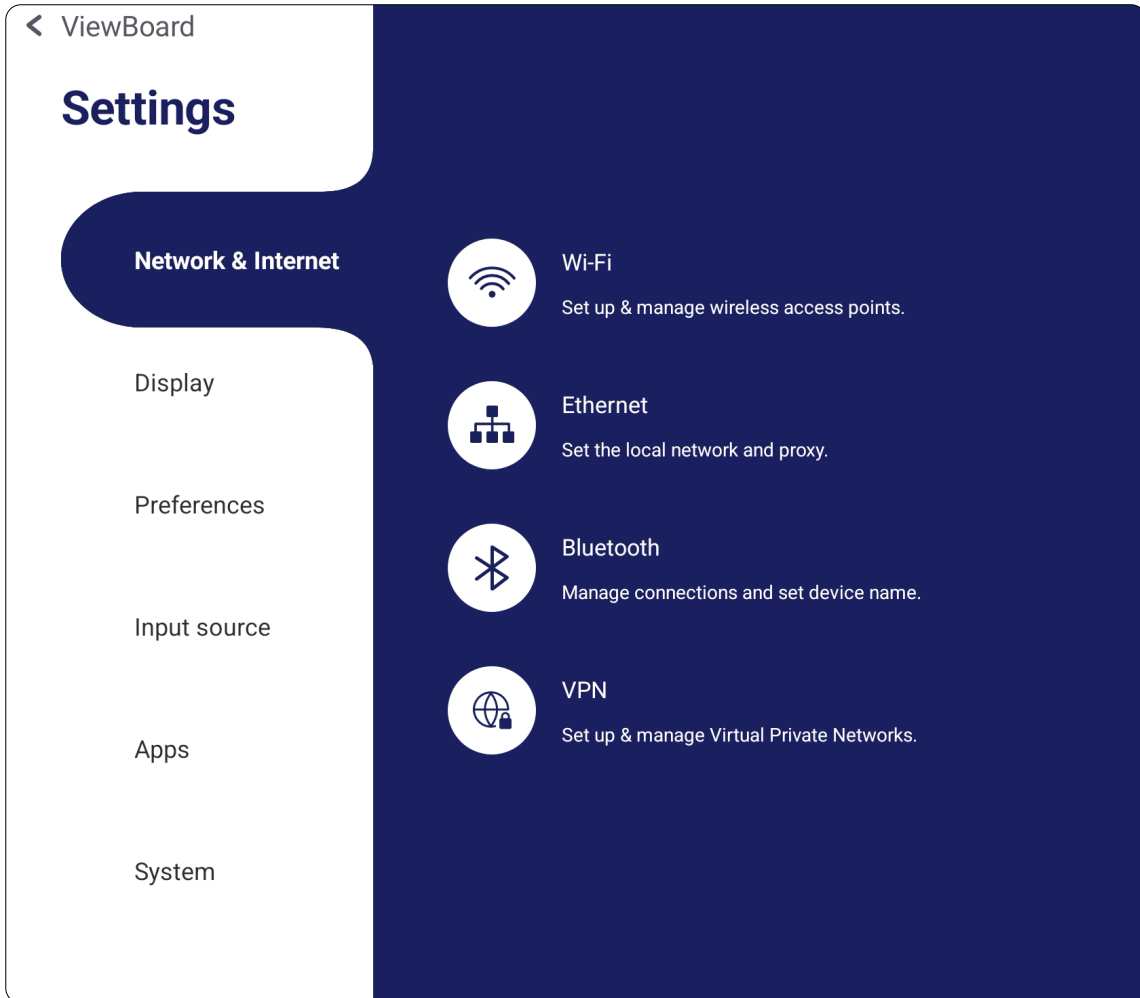

NOTE:

- **Wi-Fi**, **Wireless hotspot**, and **Bluetooth** settings will appear when an optional Wi-Fi card (e.g., VB-WIFI-005) has been installed in the Wi-Fi slot.
- **Ethernet** will disable automatically when **Wi-Fi** is enabled. **Wi-Fi** will disable automatically when **Ethernet** is enabled. Wi-Fi will disable when **Wireless hotspot** is enabled.
- The device cannot connect to the Internet when **Wireless hotspot** is enabled.

Wi-Fi

Setup, manage wireless access points, and share internet connection by hotspot.

- Tap the toggle button to turn Wi-Fi **On** or **Off**.

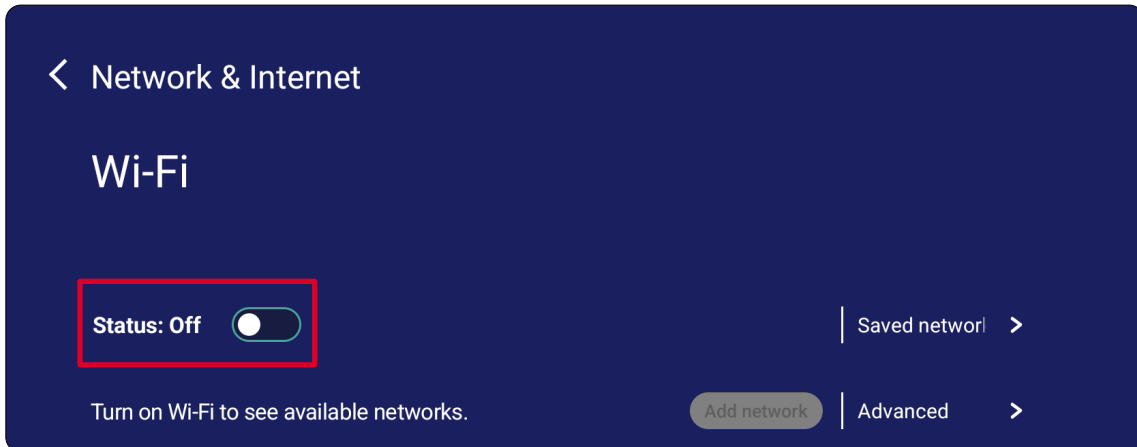

- Once **On**, you can: **Add a Network**, view **Saved Networks**, **Refresh** the network list, or view **Advanced** settings.

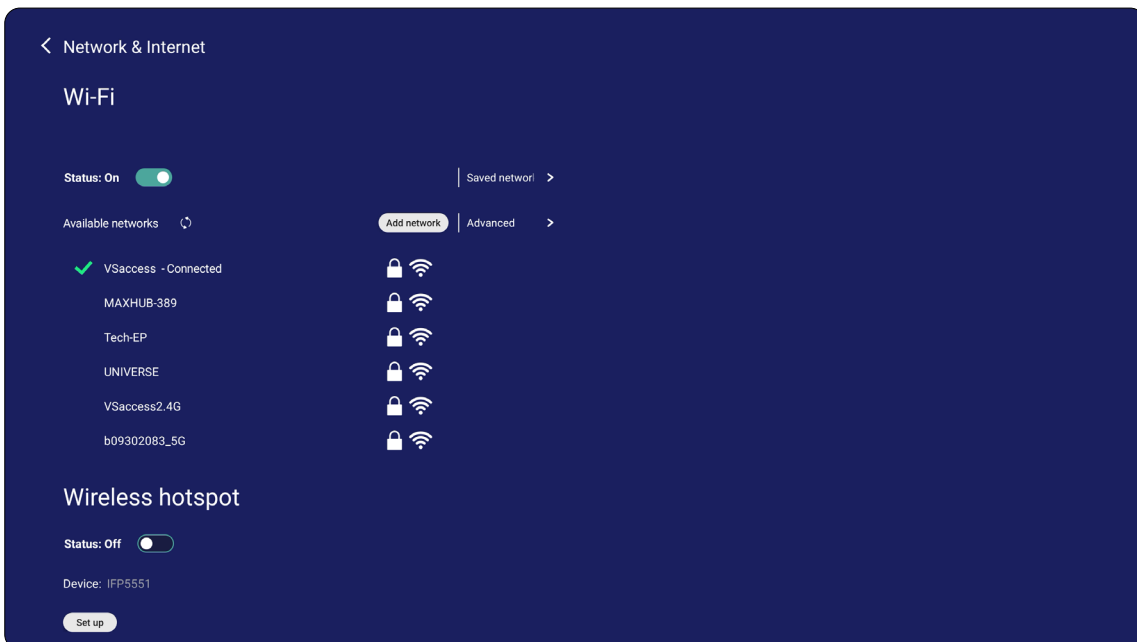

- In **Advanced** settings, you can toggle **Network notifications On** or **Off** and view **Network card info**.



To share your internet connection with other devices.

1. Tap the toggle button to turn **Wireless hotspot** On or Off.

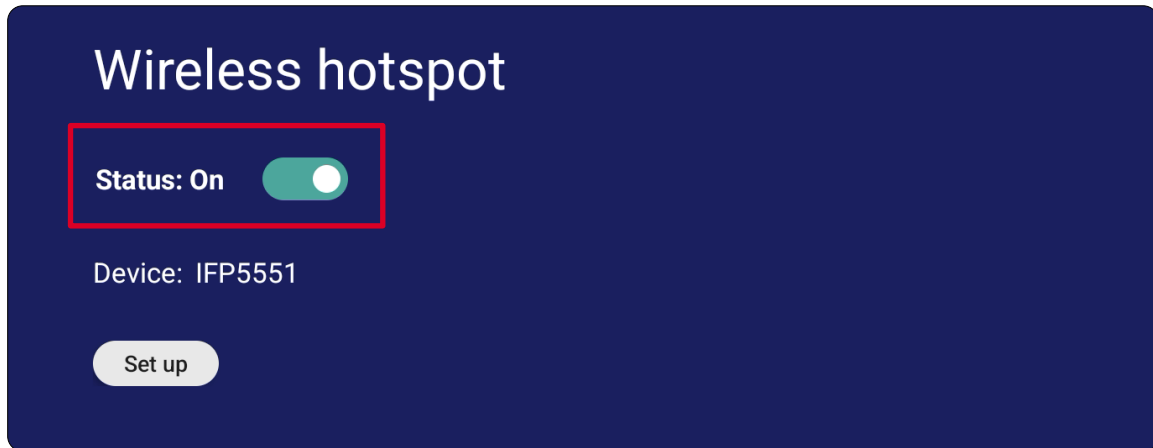

2. Tap Set up to set the Network name, Security, and Password.

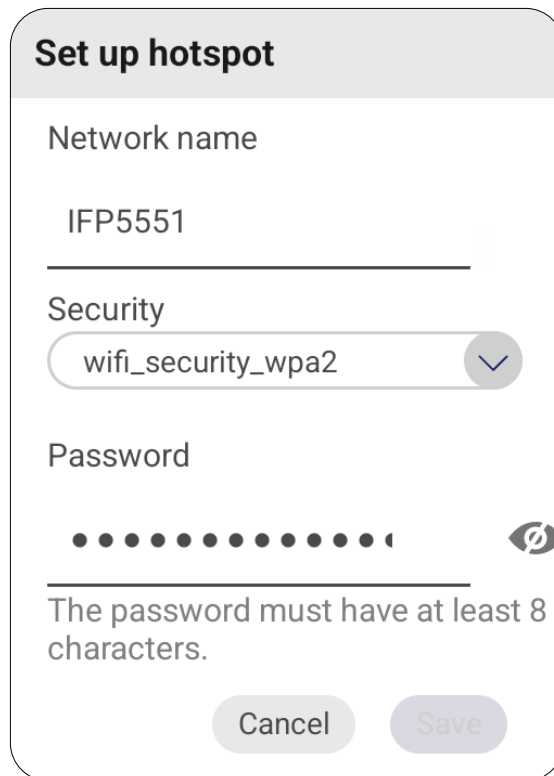

Ethernet

Set the local network and proxy.

- Tap the drop down menu to connect/disconnect the Ethernet.

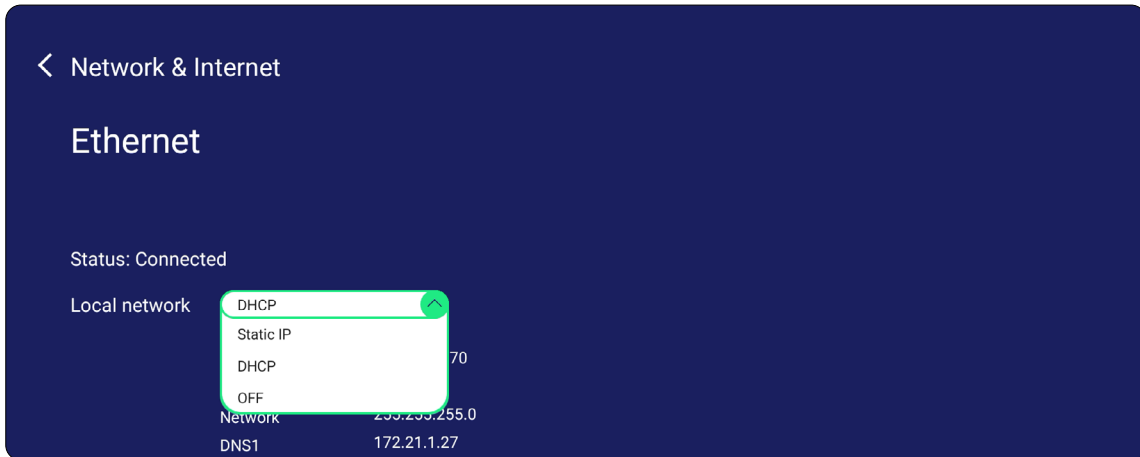

- You can adjust **Local network** and **Proxy** settings as well.

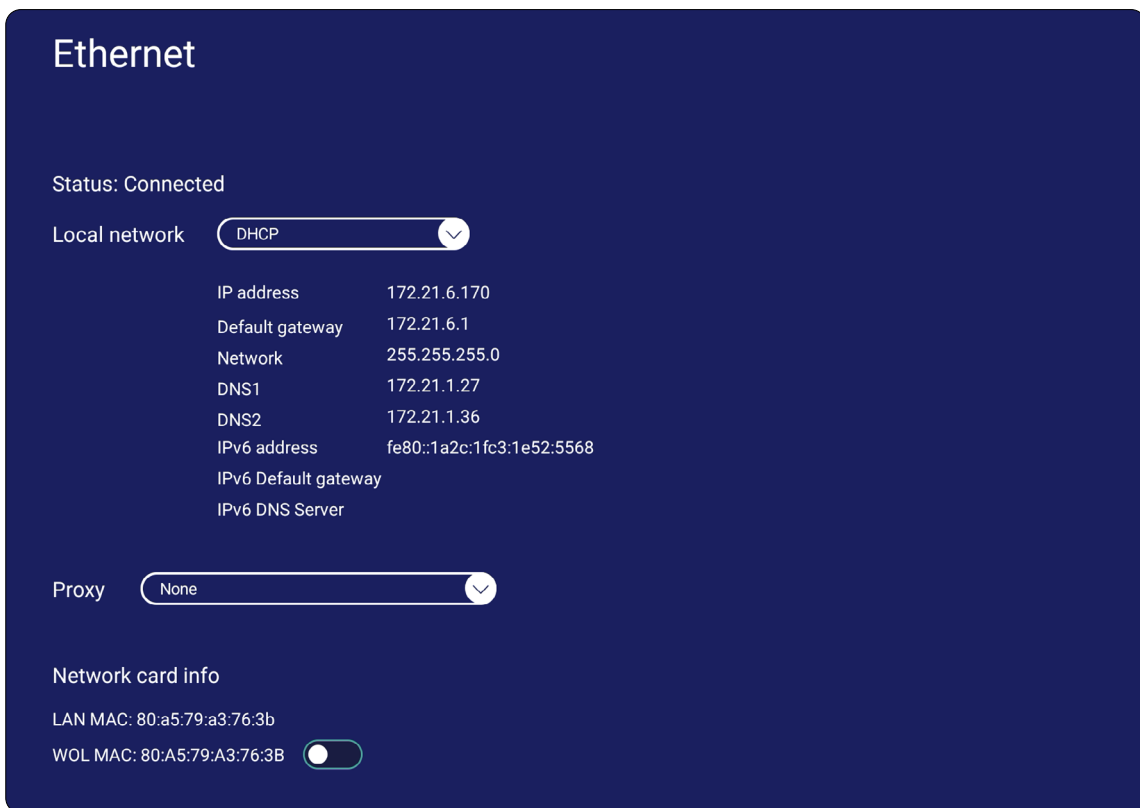

Bluetooth

Manage connections, set the device name and discoverability.

- Tap the toggle button to turn Bluetooth **On** or **Off**. Once **On**, users can select a listed device to pair and connect to, rename their device, remove a device.

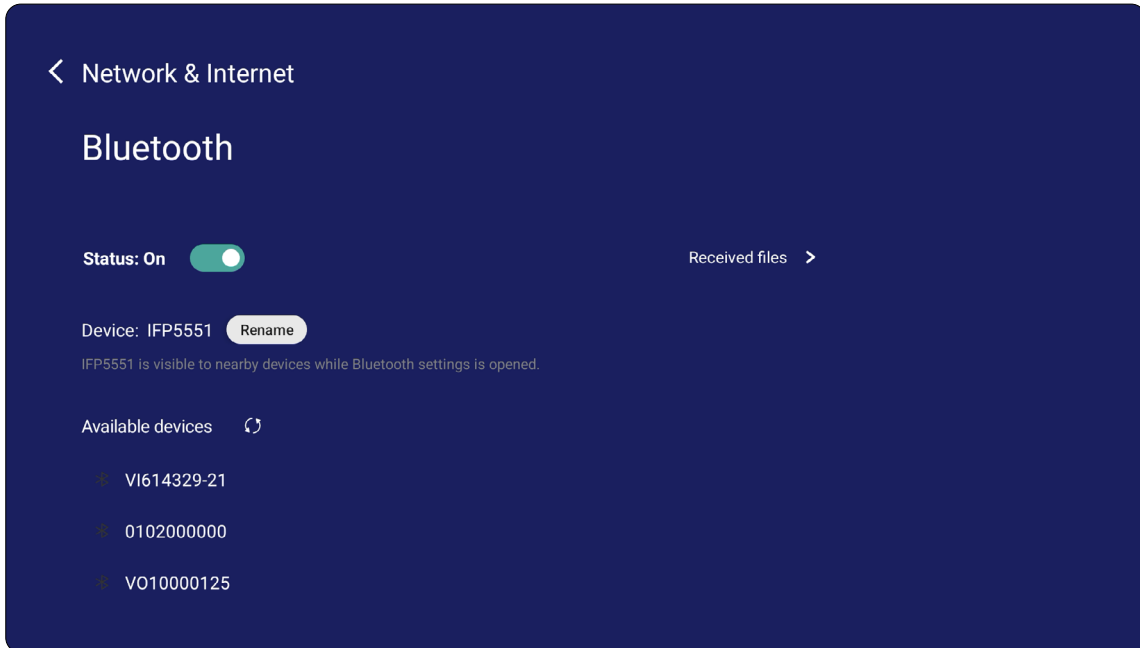

VPN

Setup and manage Virtual Private Networks.

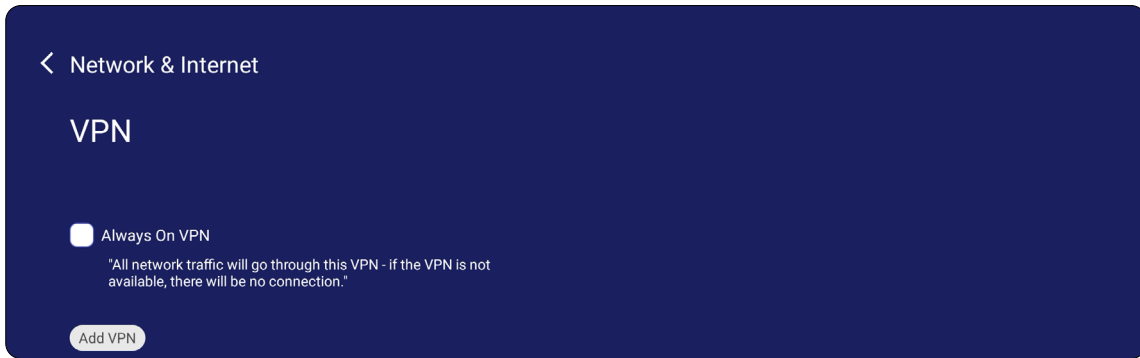

To create a VPN profile:

1. Go to: **Settings > Network & Internet > VPN** and tap **Add VPN**.

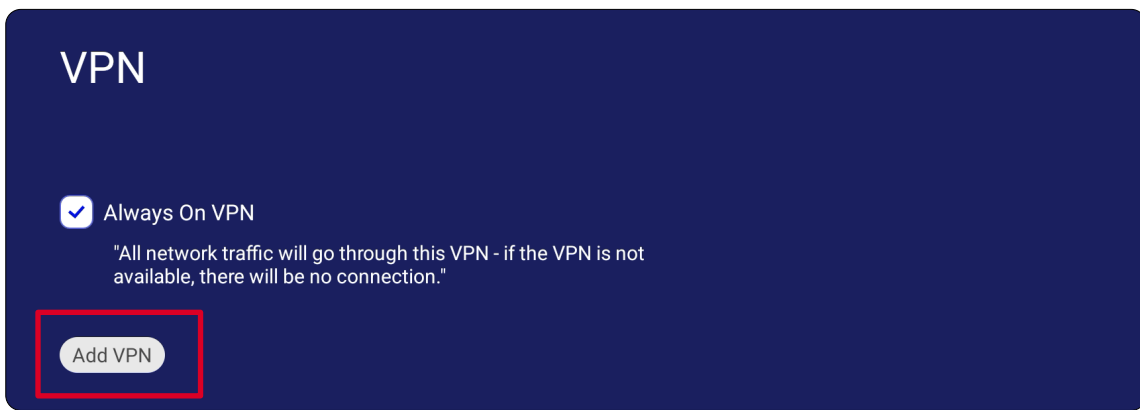

2. Key in the **Name**.

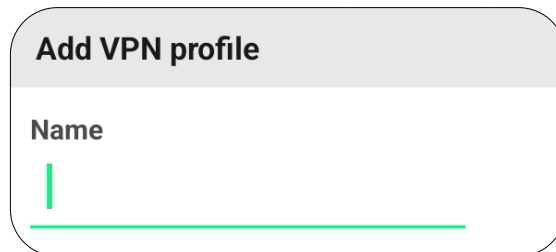

3. Select the VPN Type.

Add VPN profile

Name

|

Type

- IKEv2/IPSec MSCHAPv2 
- IKEv2/IPSec MSCHAPv2
- IKEv2/IPSec PSK
- IKEv2/IPSec RSA

Display

Adjust the **Wallpaper**, **Protection**, and **HDMI Out** settings.

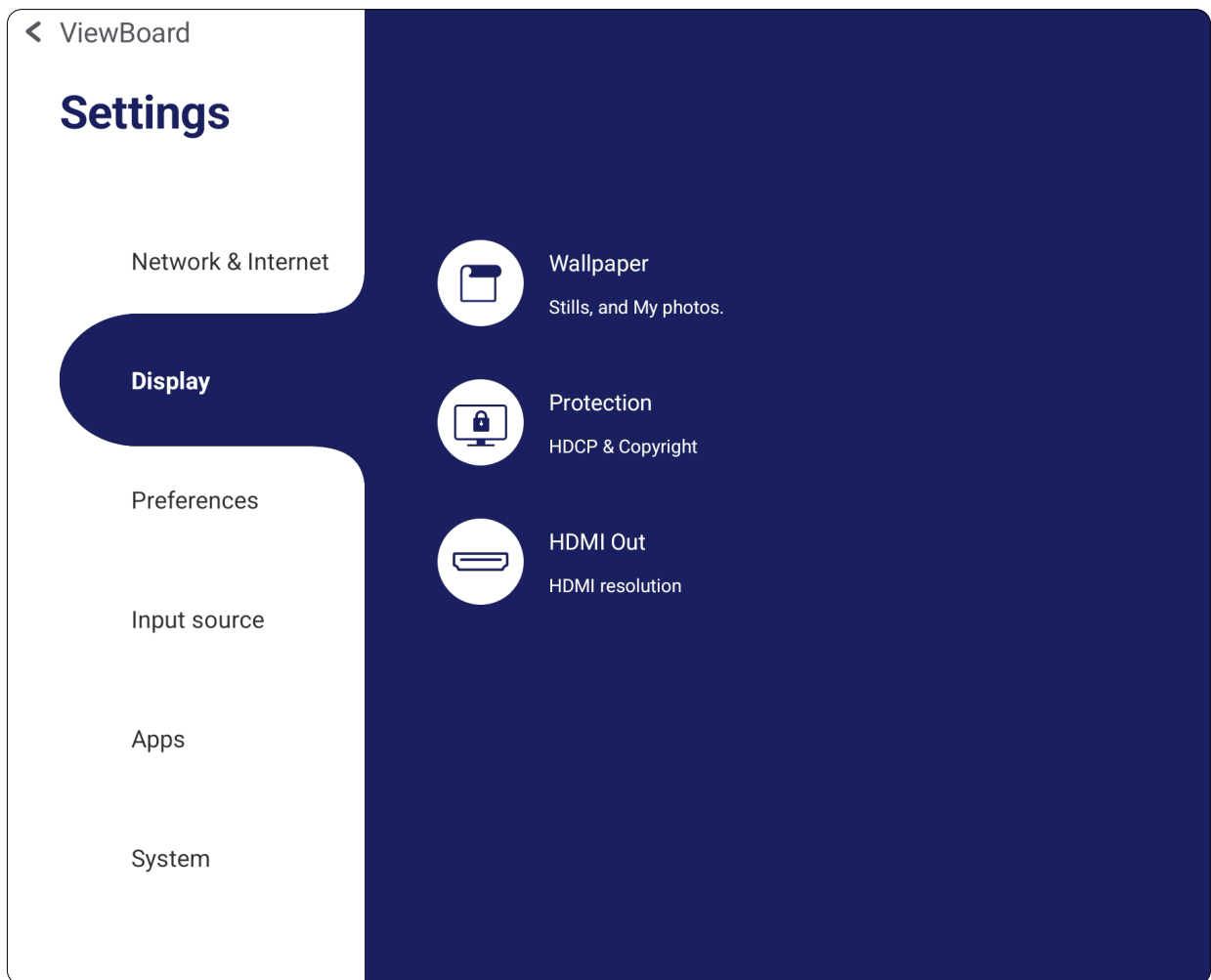

Wallpaper

Users can change their wallpaper with default images, or use their own by tapping the add icon (+) and selecting the image file.

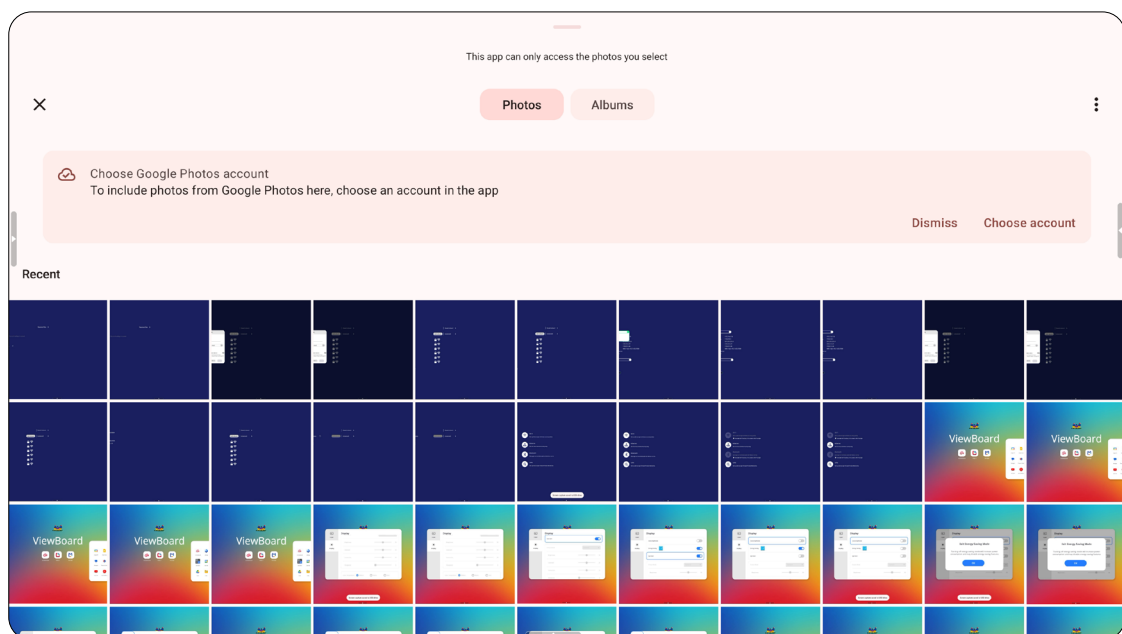
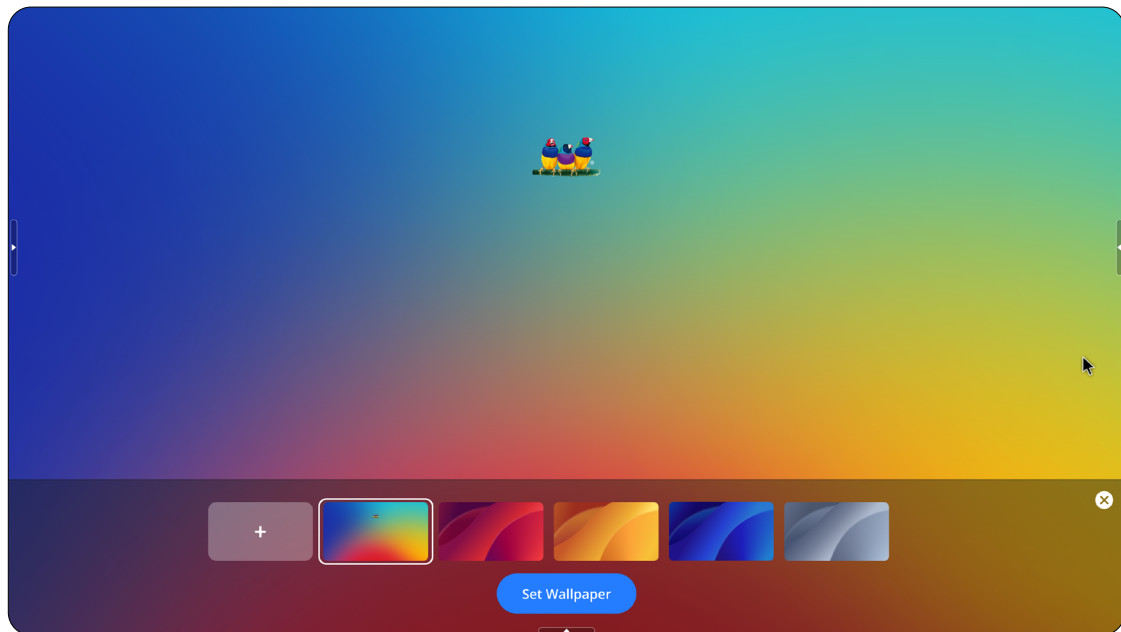

Protection

Set HDCP & Copyright on or off.

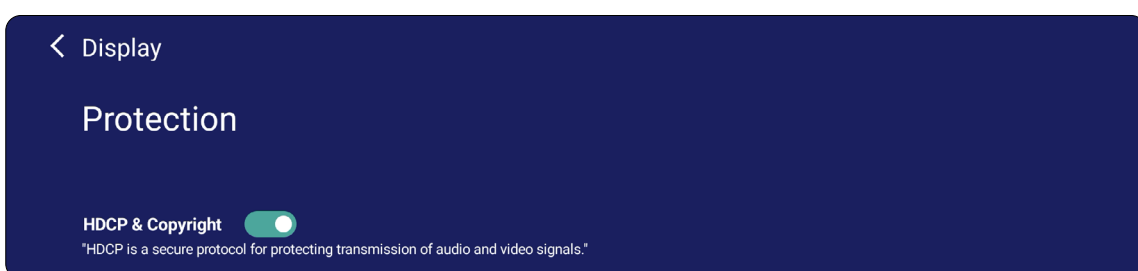

HDMI Out

Adjust the HDMI Out Resolution setting, enable video output, and mute/unmute the speakers when connected via HDMI Out.

NOTE:

- The **Disable ViewBoard Speakers when using HDMI Out** option box is not selected by default.
- Swipe up on the listed resolutions to see more supported resolutions.

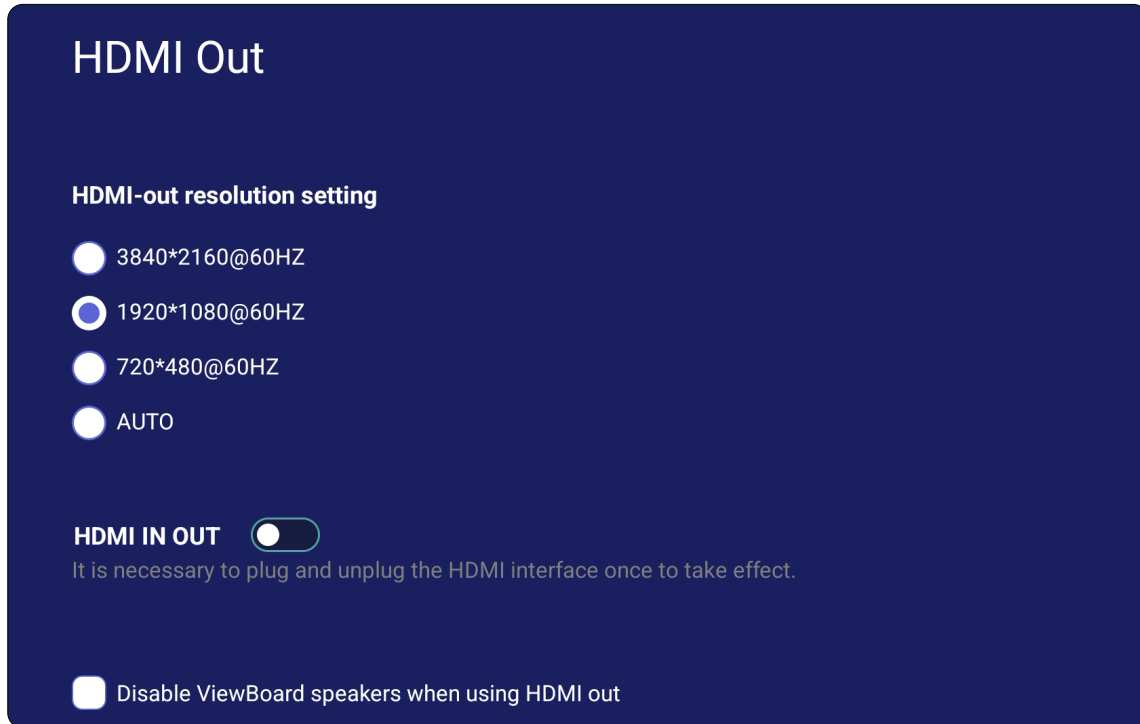

Preference

View and adjust **Touch, Language, Keyboard & Input, Date & Time, Boot Mode & Advanced, Start up & Shut down, and Toolbar** settings.



Marker

Toggle **WriteAway** On/Off for the Marker or myViewBoard whiteboard tool.

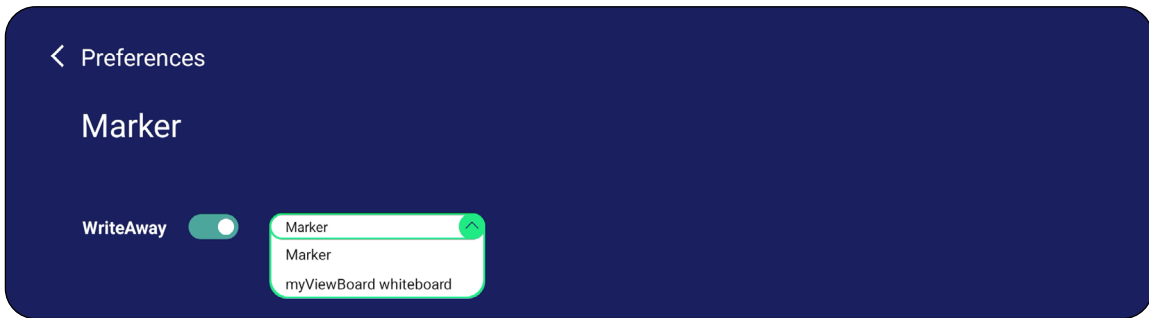

Touch

Adjust **Touch Settings** and toggle **Touch Sounds** and **Windows Ink** On/Off.



Language

Adjust and choose the preferred language from the available languages.

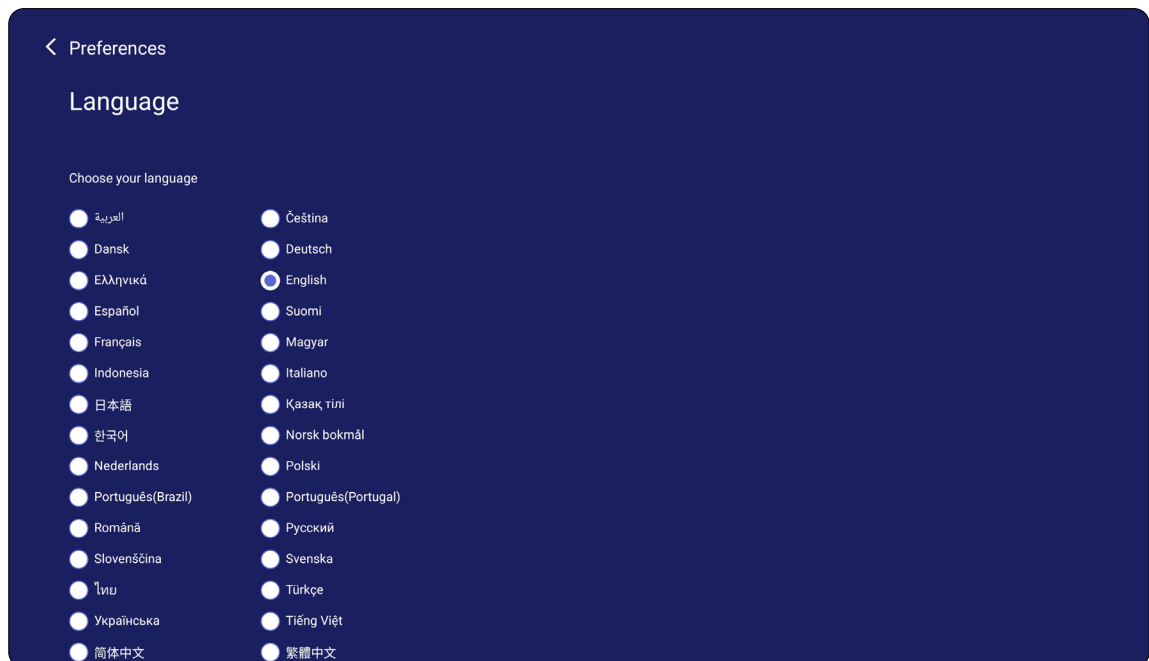

Keyboard & Input Method

Enable/disable the visual keyboard and/or change the default input method.

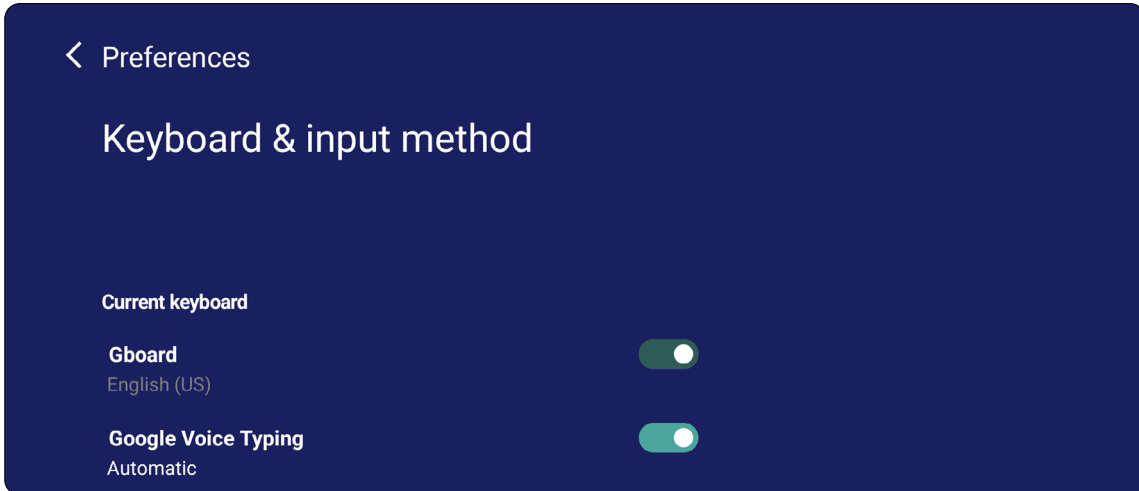

Date & Time

Set the system time and format.

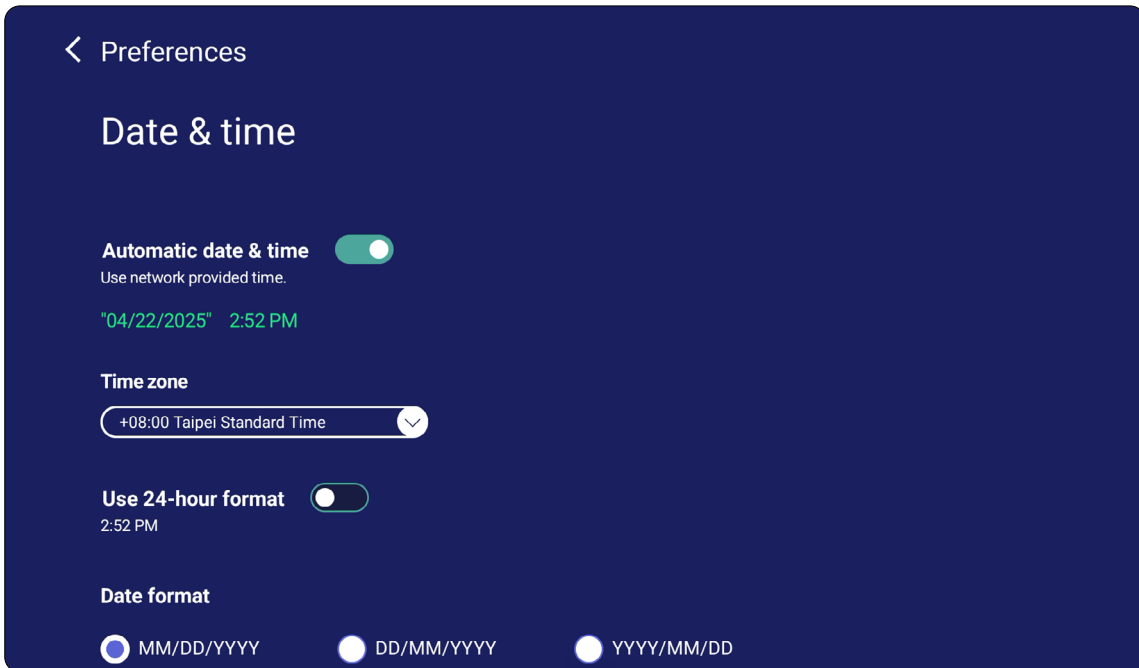

Item	Description
Automatic Date & Time	When enabled, the ViewBoard will automatically synchronize the date and time via the Internet.
Time Zone	Select the appropriate time zone.
Time Format	Choose from 12-hour or 24-hour time format. Simply toggle 24-hour format On/Off.
Date Format	Select from the available date formats.

Boot Mode & Advanced Settings

Adjust the preferred boot up mode and set/reset a password.

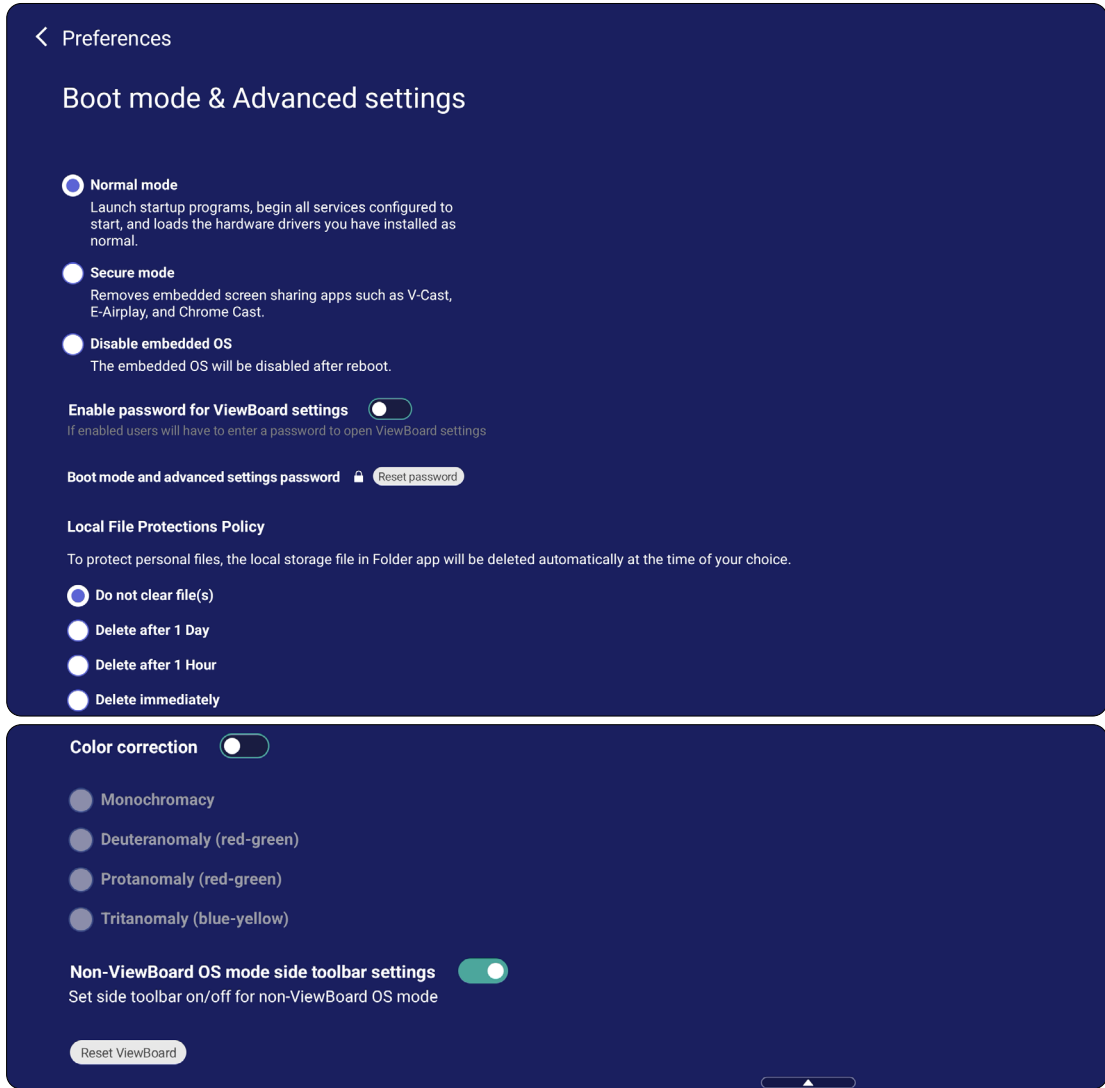

Item	Description
Normal Mode	The embedded screen sharing Apps will run normally.
Secured Mode	The embedded screen sharing Apps will be removed.
Disable Embedded OS	The system will automatically reboot, and then the Embedded OS will not appear.
ViewBoard Settings Access Password	Toggle to lock/unlock the ViewBoard Settings.
Password for Protection	Modify the Boot mode and ViewBoard Settings entry password.
Local File Protection Policy	Choose how long to keep local storage files in the Folder application.

Item	Description
Color Correction	Color correct the ViewBoard display screen.
Non-ViewBoard OS Mode Side Toolbar Settings	Toggle to turn On/Off the side toolbar for non-ViewBoard OS environment.
Reset ViewBoard	Reset the ViewBoard to its factory default settings.

Startup & Shutdown

Set the **Startup Input**, **Standby Mode**, **EnergyStar Mode**, **Black Screen After Startup**, **Power off Reminder** timer and **Schedule** settings.

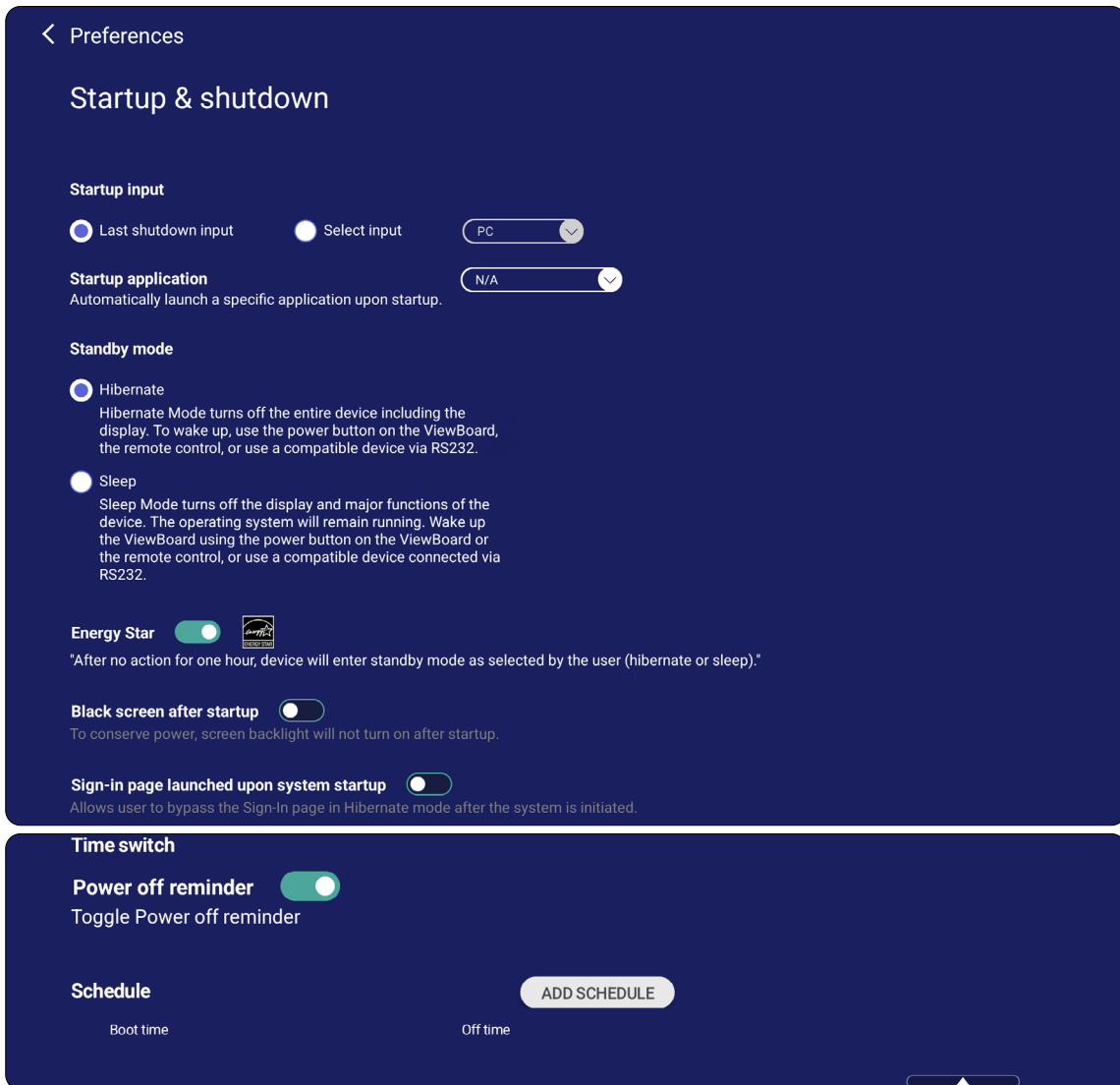

Item	Description
Startup Input	Adjust the Startup Input preference.
Startup Application	Open an application automatically when logging in.
Standby Mode	Decide what happens when you press the Power button while the ViewBoard is On.
Energy Star	Enable to automatically initiate Sleep Mode when the screen is idle for one hour.
Black Screen After Startup	When enabled, the ViewBoard will turn off the backlight automatically after booting up.

Item	Description
Sign-in Page Launched Upon System Startup	Enable to skip the sign-in screen when waking up the ViewBoard from Sleep Mode.
Time Switch	When enabled, the ViewBoard will turn off without a notification after a set period of time.
Schedule	Schedule a Boot and Shut off time.

Toolbar Setting

Adjust the Side toolbar settings.

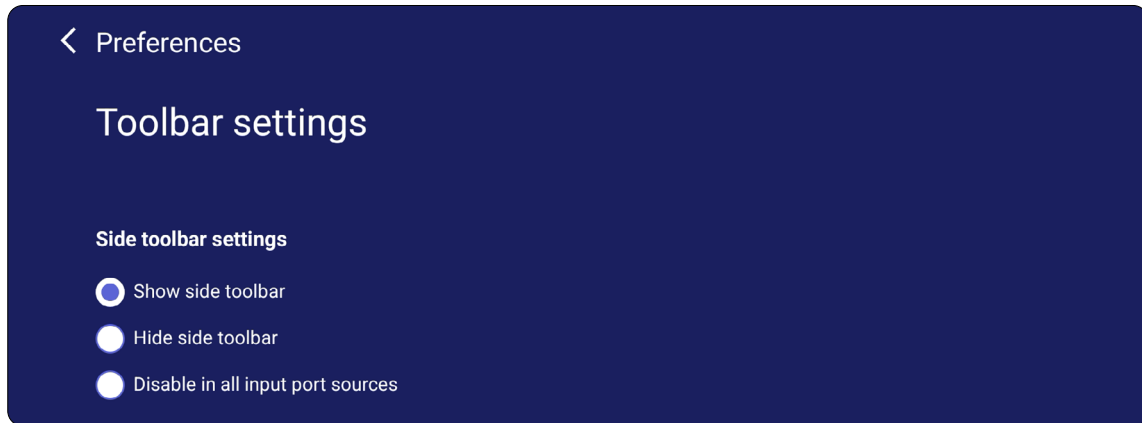

Sound Setting

Output audio from the preferred output source.



Input Source

Adjust the input source names and settings, as well as the side toolbar settings.

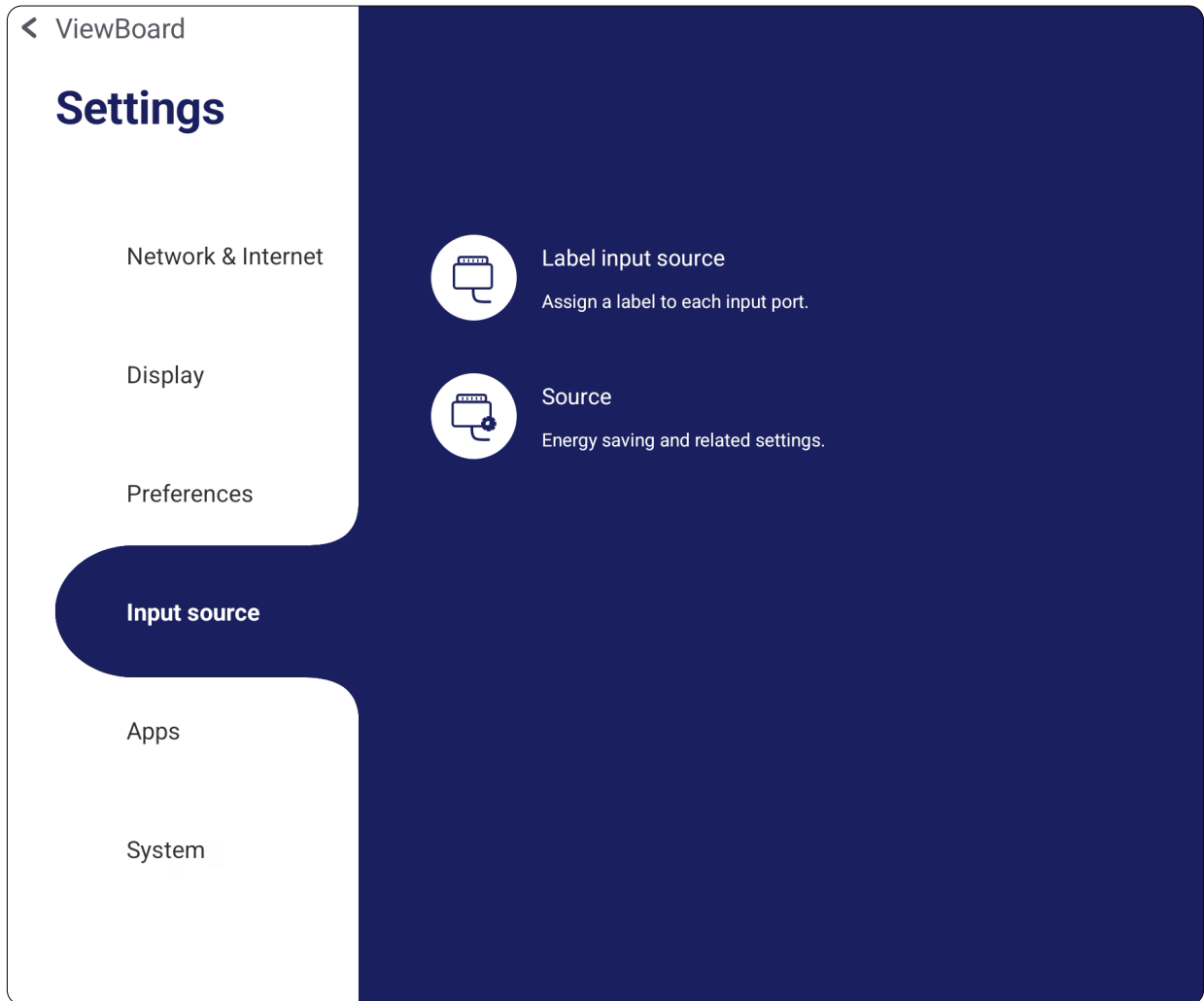

Label Input Source

Set labels for each input source that will be easily recognized when displayed.

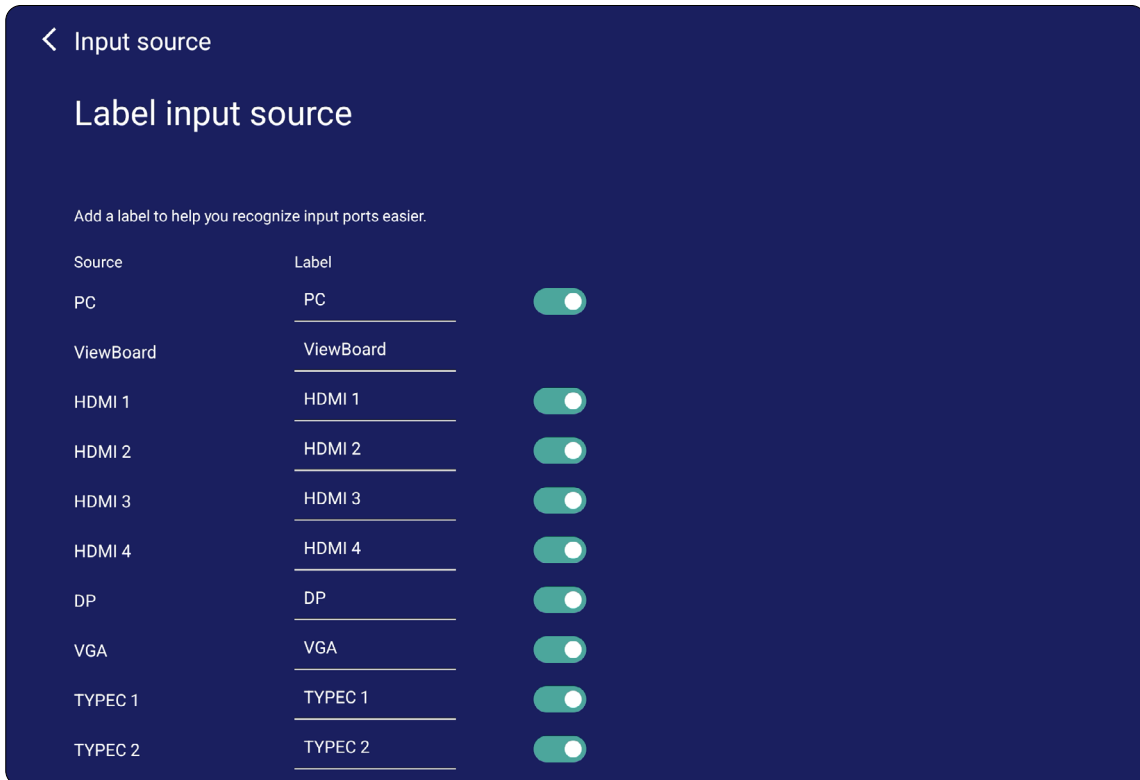

Source

Toggle **Wake up by active HDMI input** or **HDMI CEC On/Off**, and select one of the **Auto switch input ports** options.

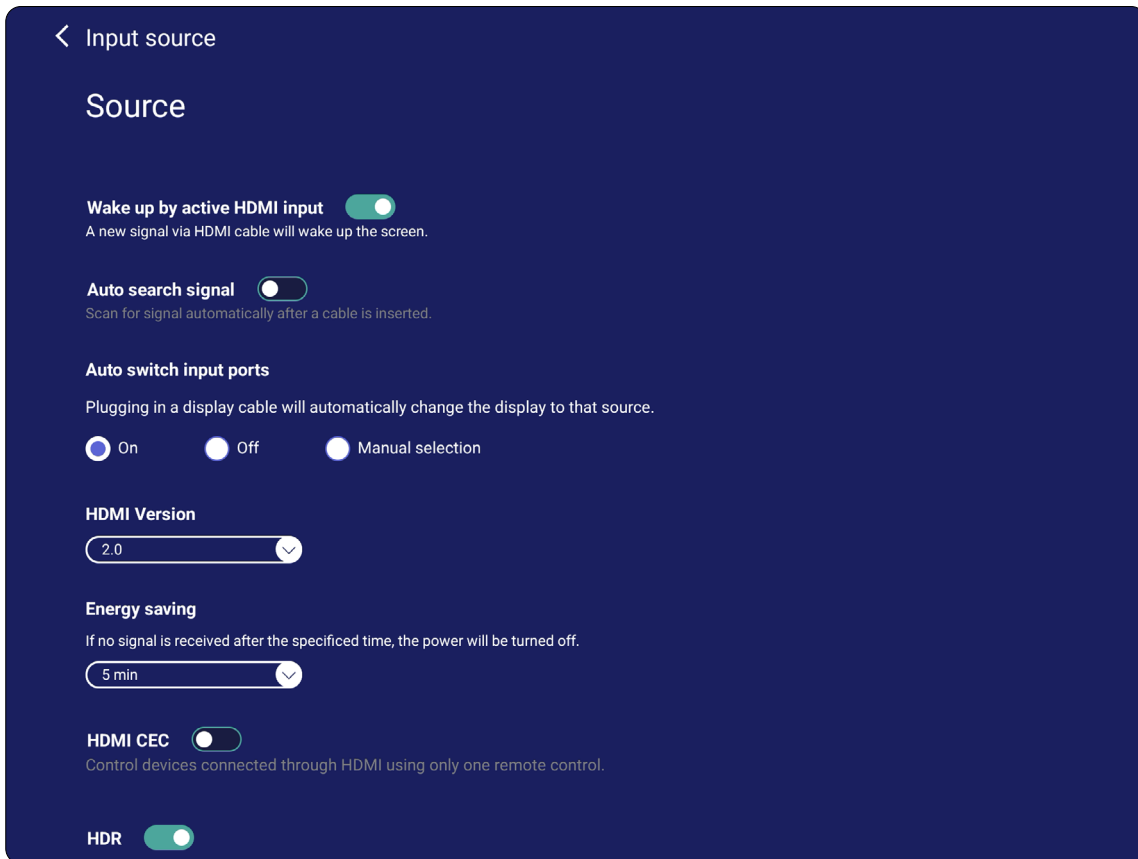

Item	Description
Wake up by Active HDMI input	The screen will turn on automatically after plugging in an HDMI cable when the screen is off.
Auto Search Signal	When enabled, if the current source does not have a signal, the ViewBoard will automatically search for an input source.
Auto switch input ports	The original signal will automatically switch to a new cable after it's plugged in.
HDMI Version	Set HDMI Version.
Energy Saving	Set a time period to power off if no signal is detected.
HDMI CEC	Enable/disable HDMI CEC functions.

Apps

The user can view application information and force stop, uninstall, move to USB storage, clear data, clear cache, and clear defaults.

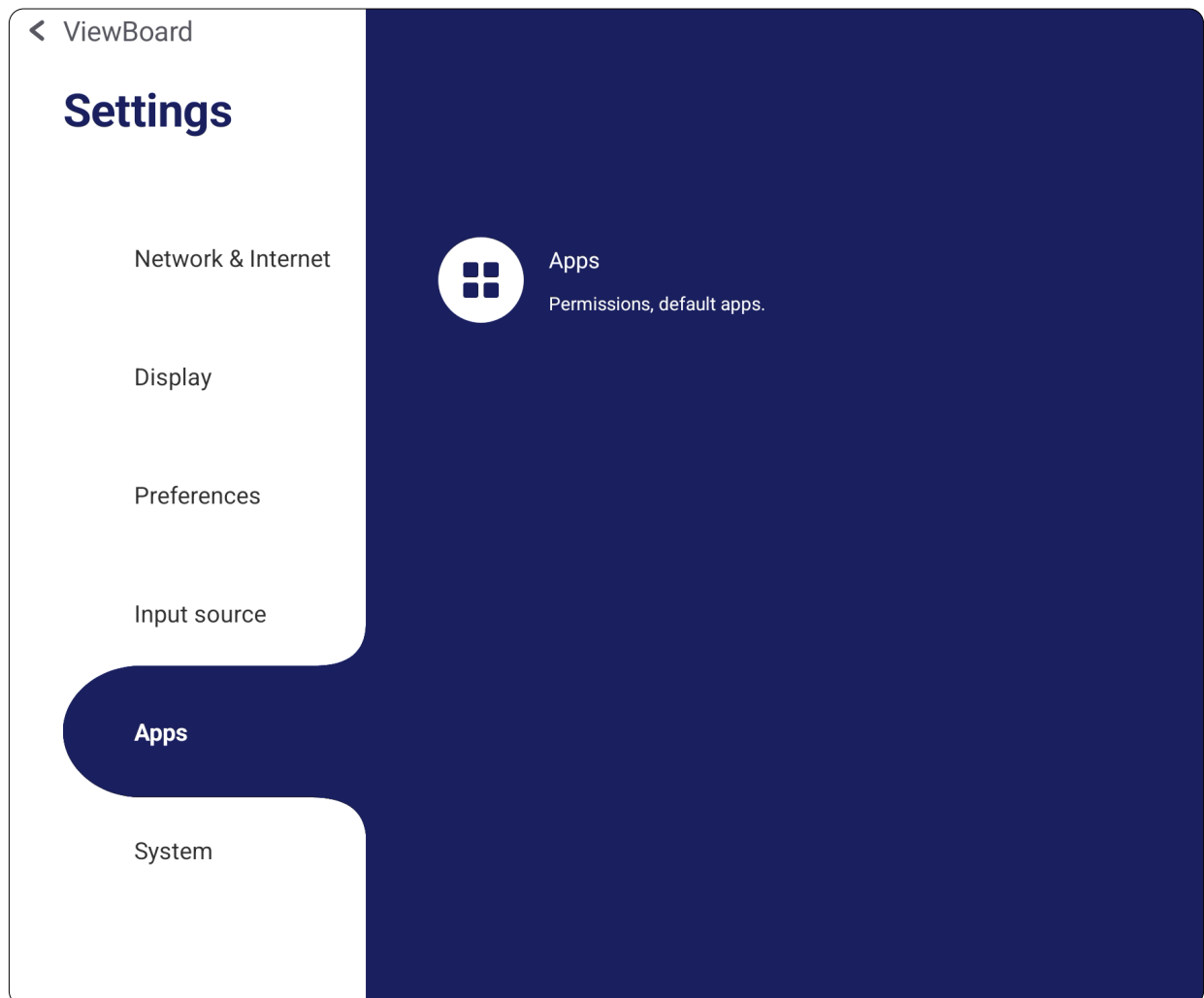

NOTE:

- Pre-loaded apps cannot be uninstalled.
- Not all apps support the move to USB storage feature.
- Not all apps support Clear Defaults.

Apps

View any running or installed applications.

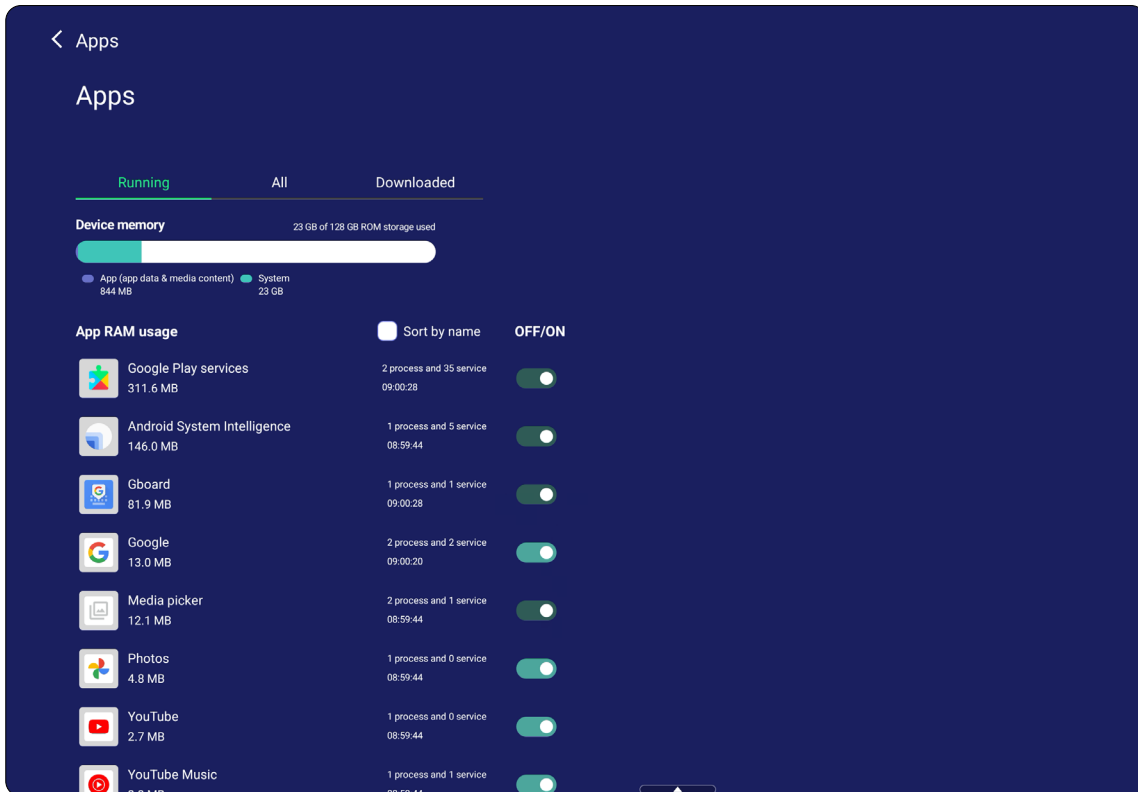

- Selecting **All** will display all installed applications.

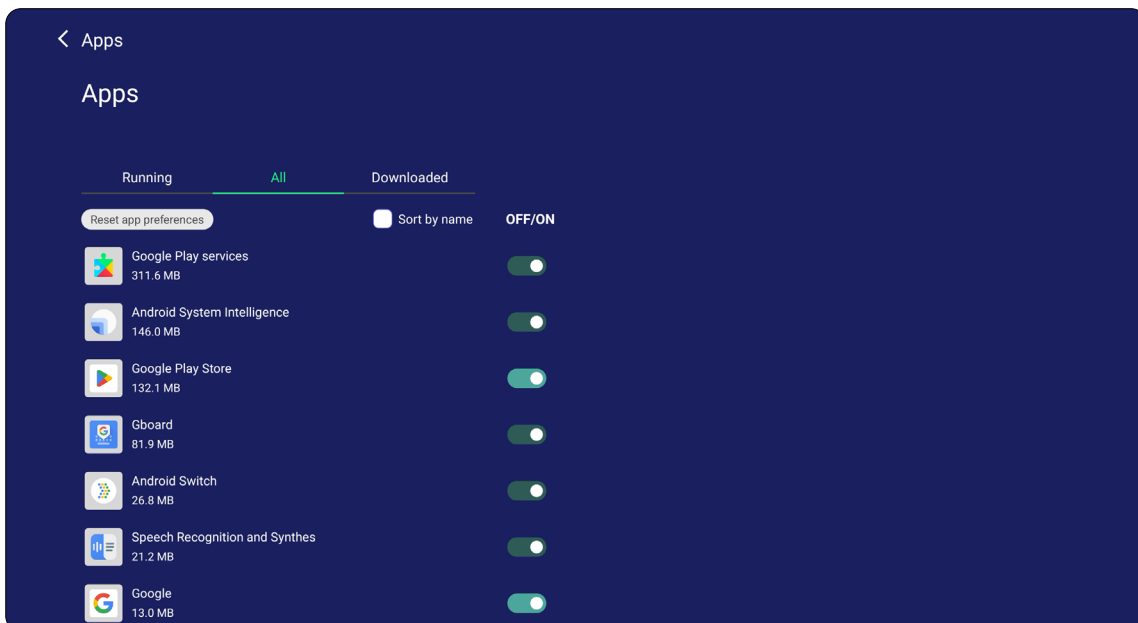

- Selecting **Download** will list all installed applications that can be uninstalled.

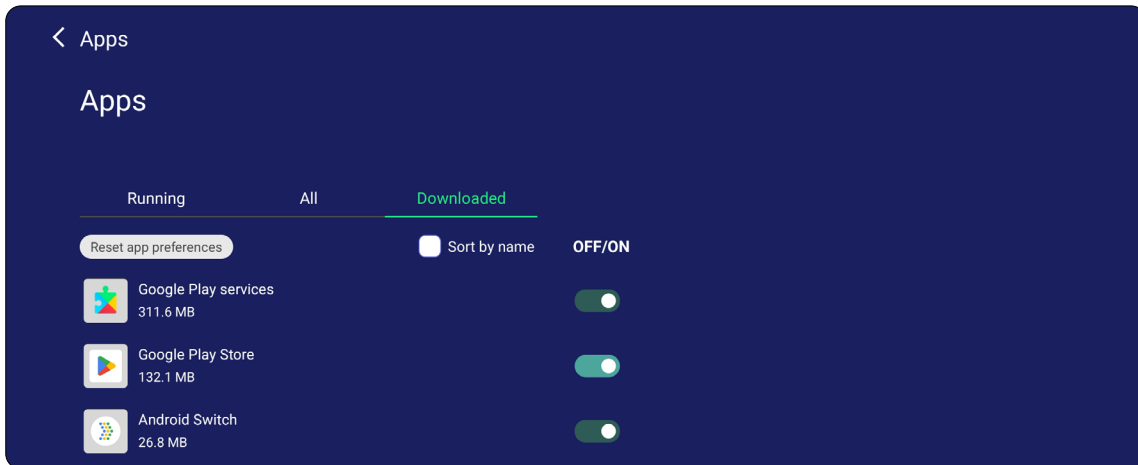

- Tapping on an application in the **Running/All/Download** panel will display further information about the application.

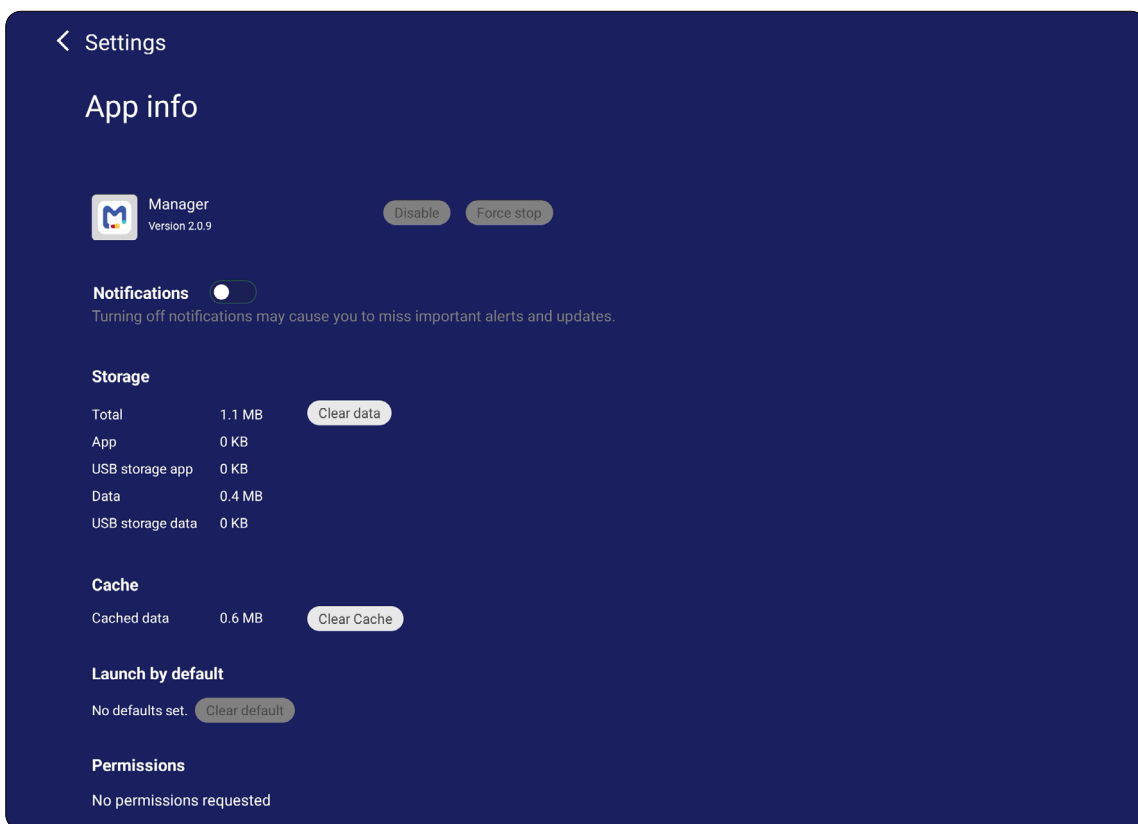

System

View and adjust **Storage**, **Clone to USB**, **Display ID**, **Security**, **System Update**, and **About device** settings.

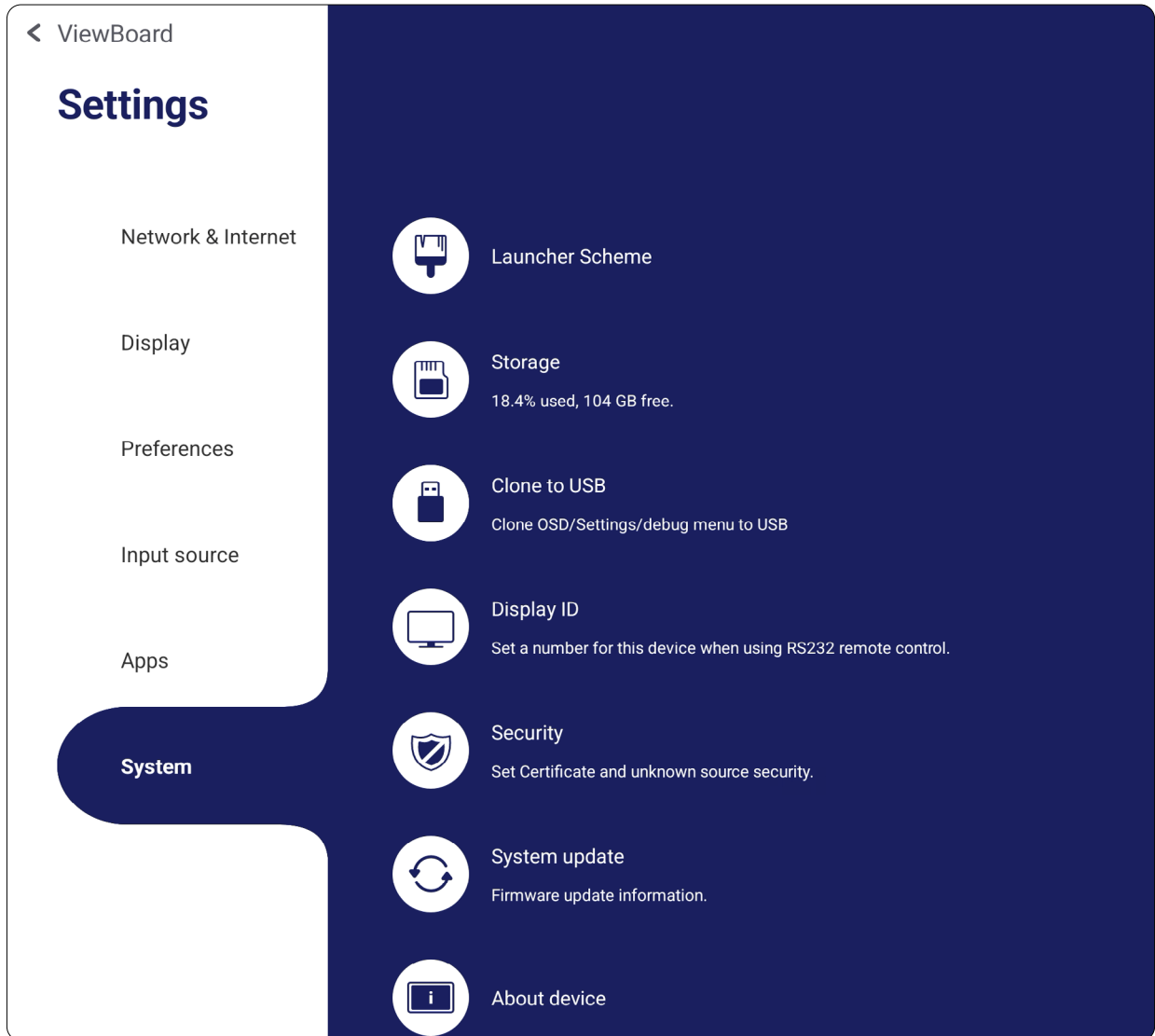

Launcher Scheme

Choose between Scheme A (Android Launcher) and Scheme B (ViewBoard Launcher) to set the Home Screen layout.

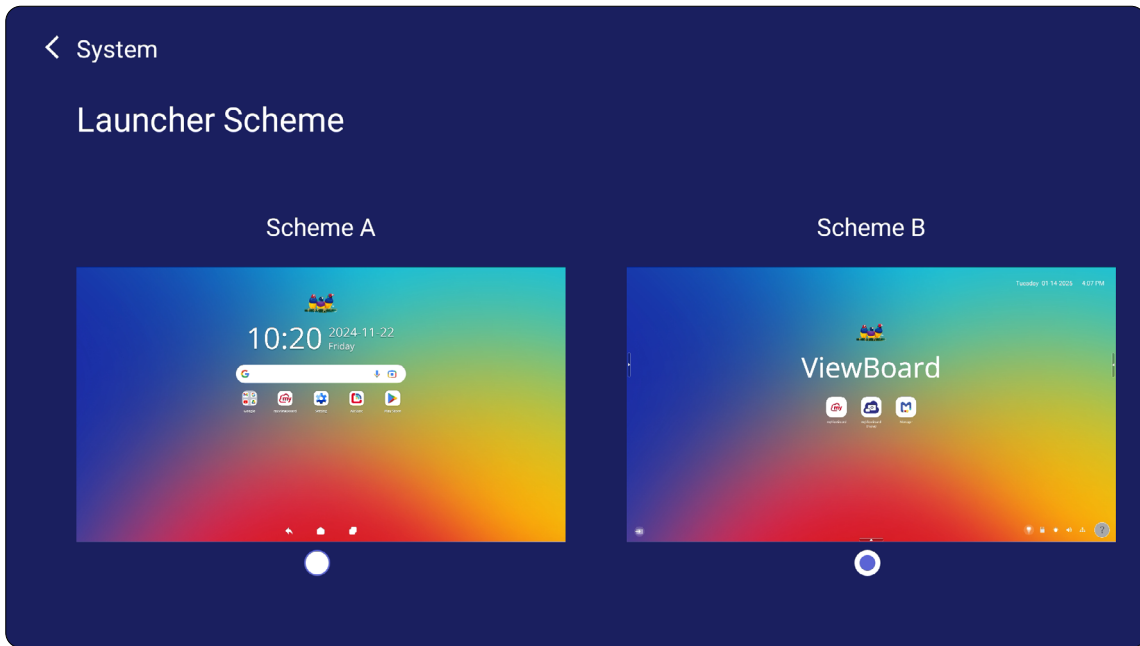

Storage

Displays all internal and external storage capacities.

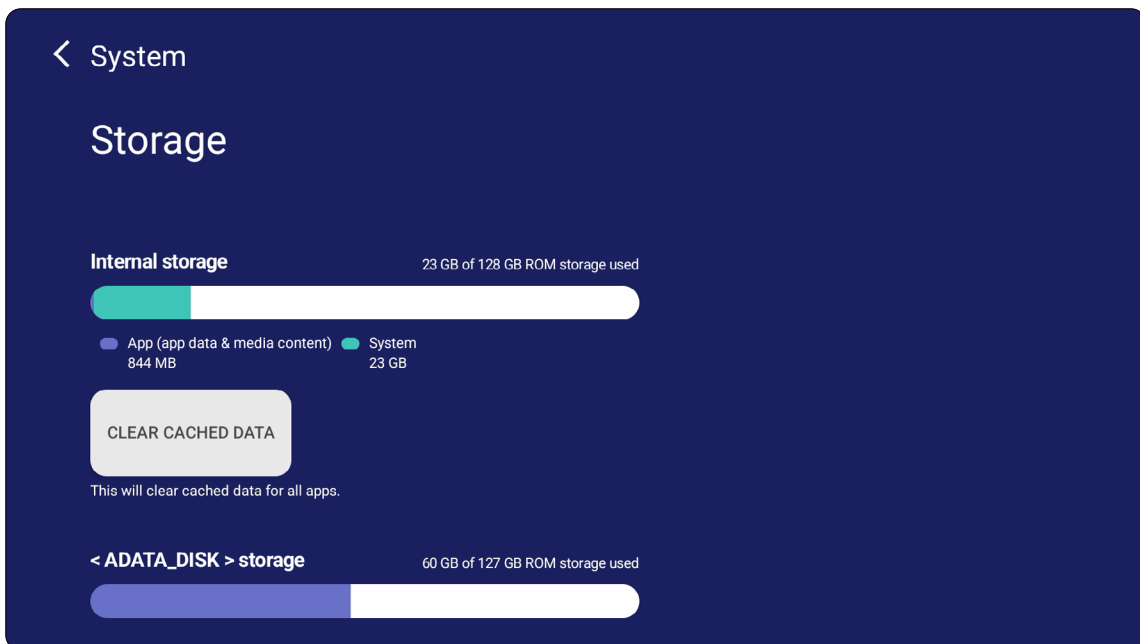

Clone to USB

Copy settings to an external USB drive.

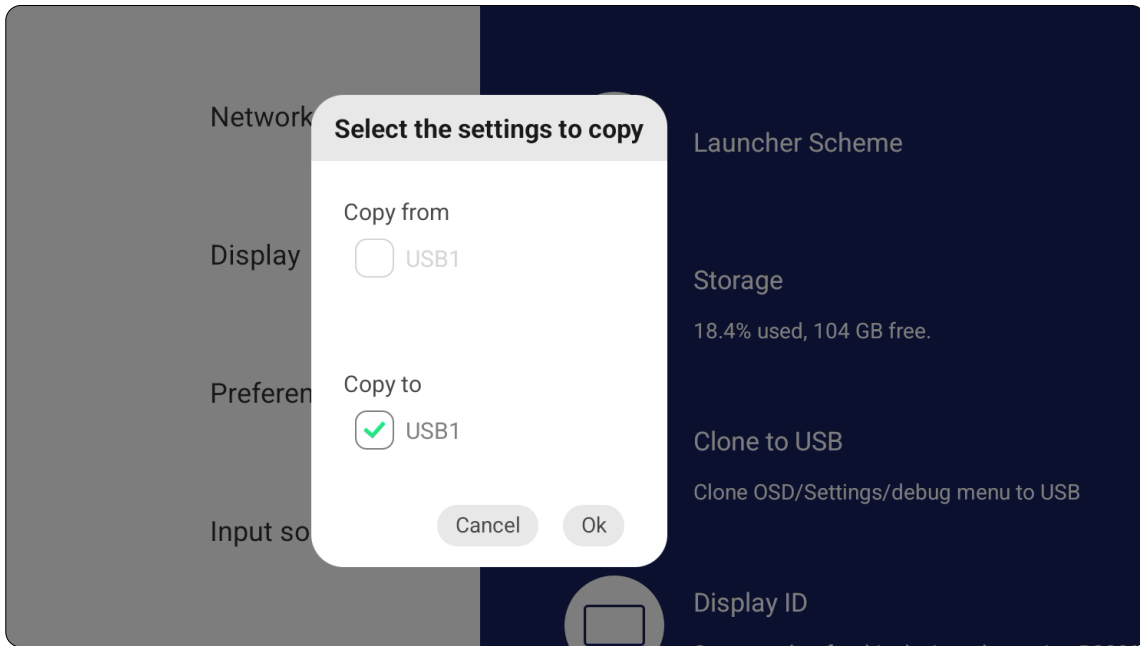

Display ID

Assign a number to remote control the display by RS-232/LAN.

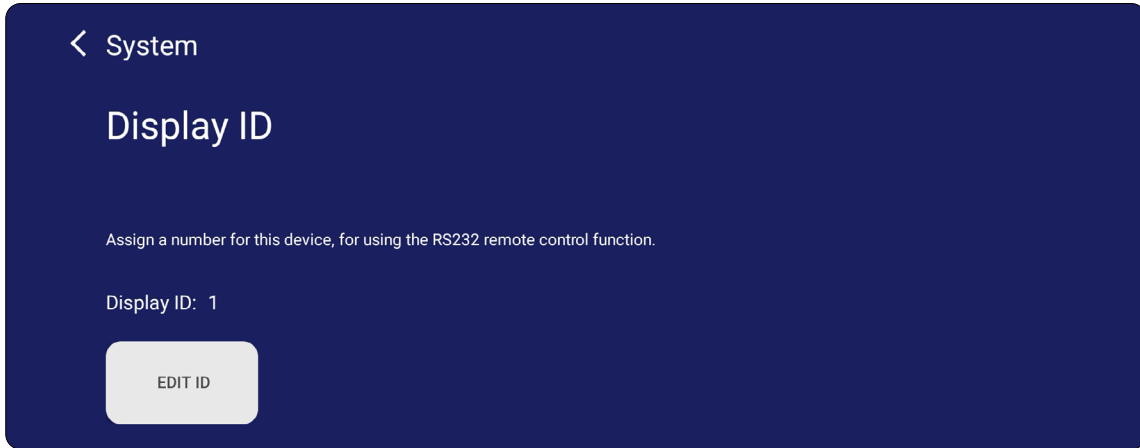

- To assign or change the Display ID, tap **Change** and input a number.

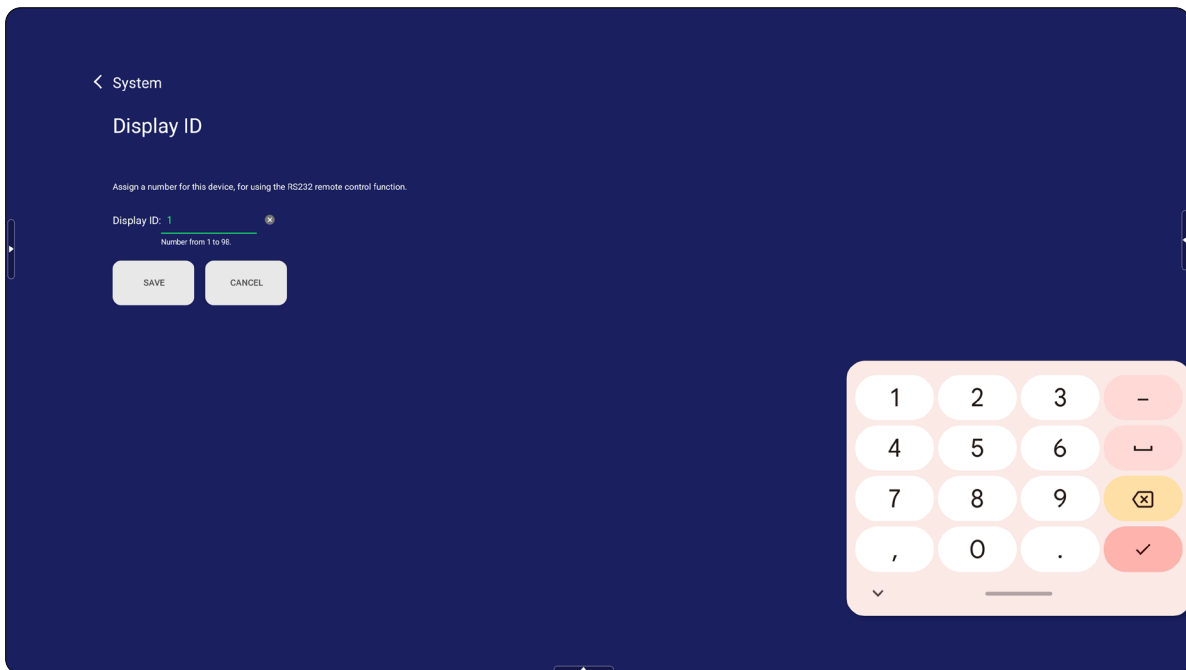

NOTE: The Display ID is for RS-232 users, and the range is 01~99.

Security

Review **Certificate**, **Trusted Credential** storage, and **Unknown sources** install settings.

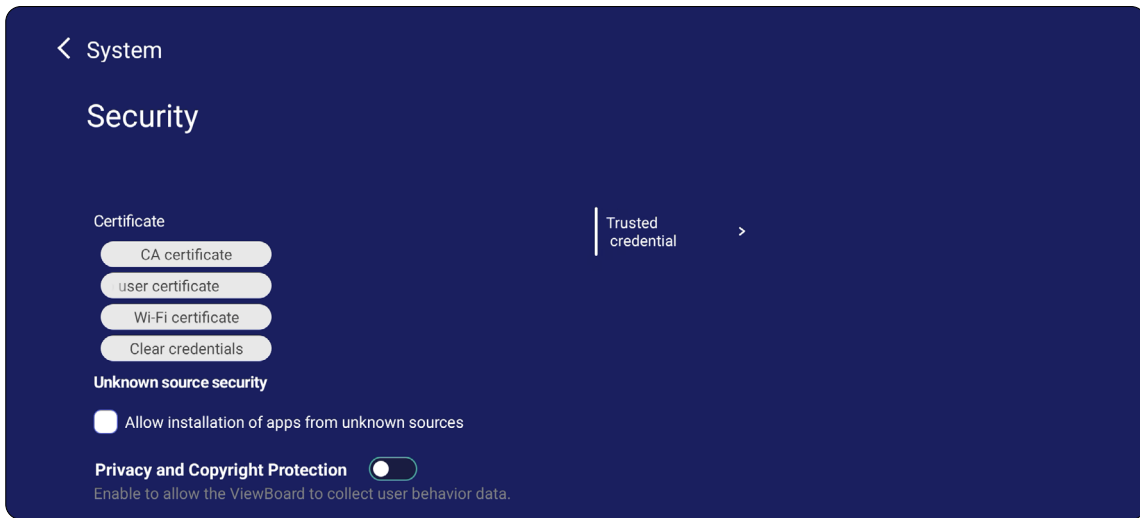

- To manually install additional certificates, tap on the certificate from the list of the available **CA/User/Wi-Fi certificate** storages. Then, tap the file.

NOTE: You may be required to enter your PIN code again to confirm the action.

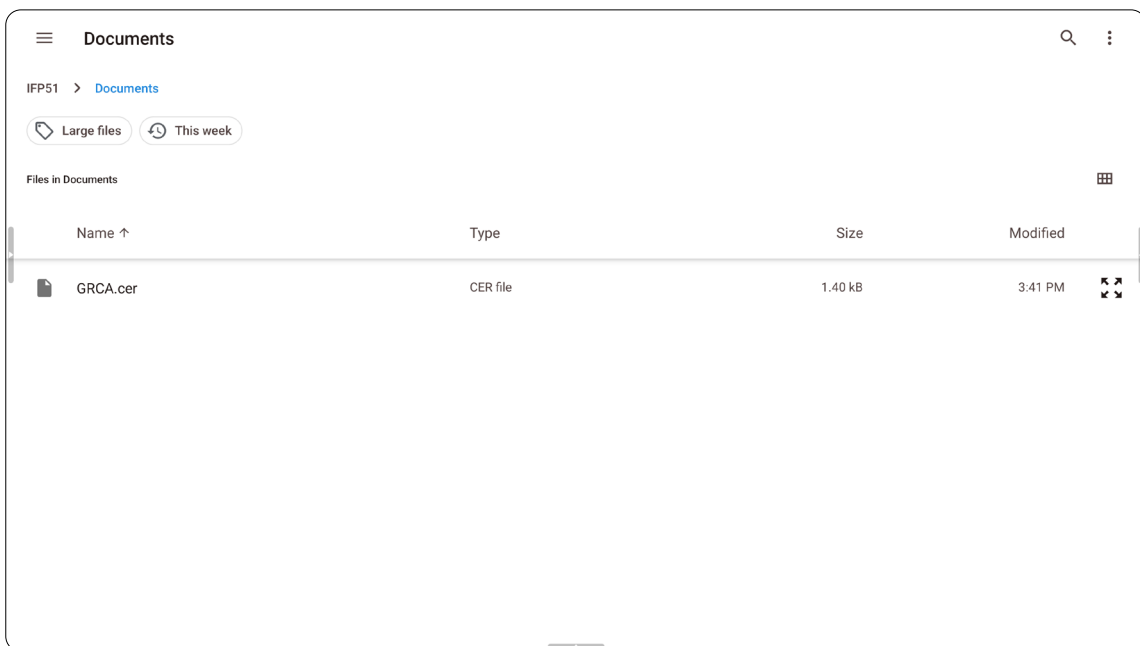

- Selecting **Clear Credentials** will remove all manually installed credentials.

1. Tap Clear Credentials > OK.

NOTE: Pre-loaded credentials cannot be cleared.

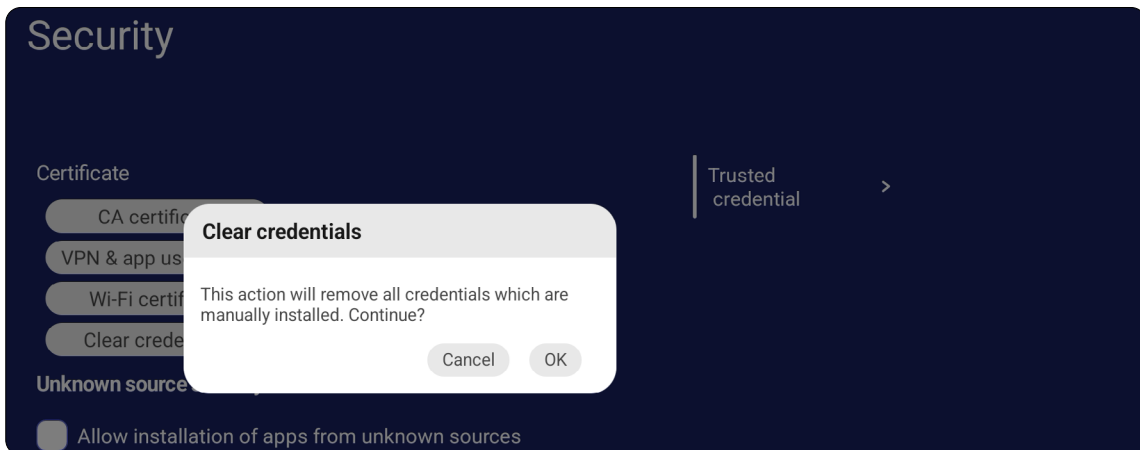

2. A confirmation message will appear when all credentials are removed.

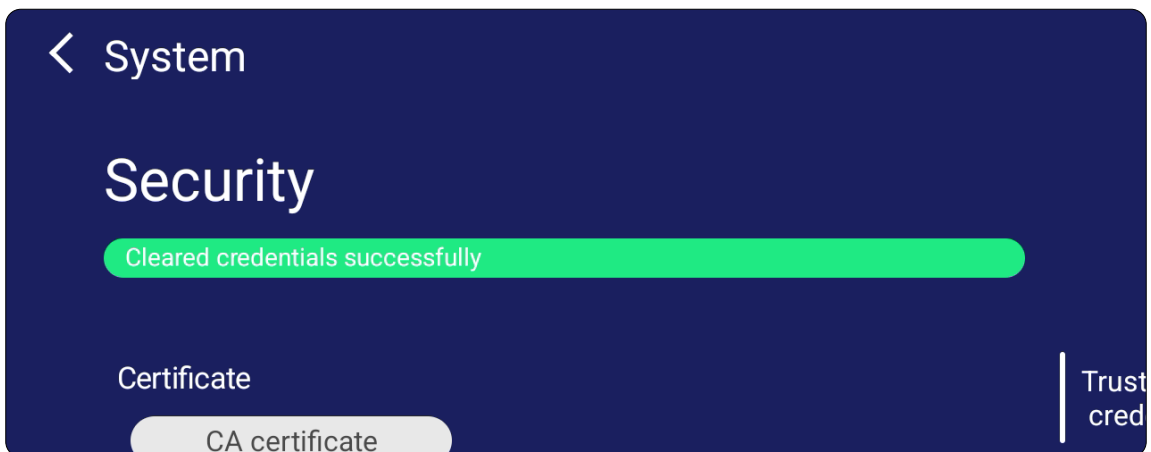

- Under **Trusted Credentials** view and edit all trusted and installed CA certificates.

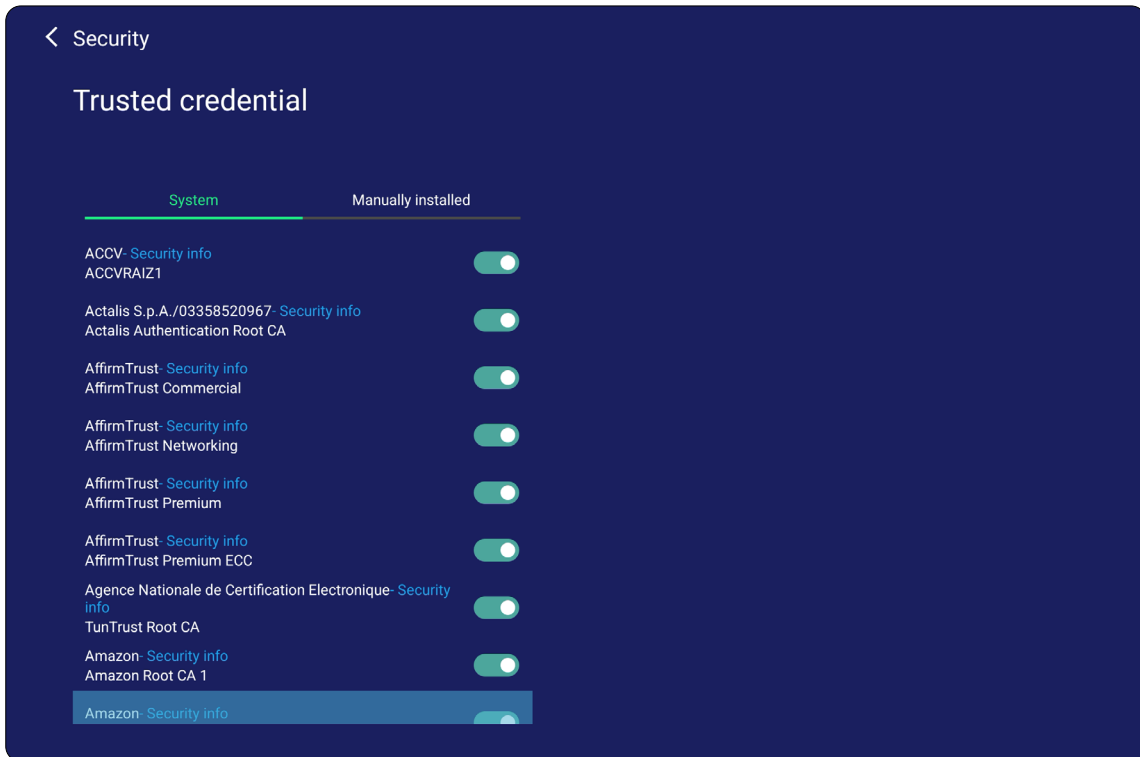

- Tapping on a credential will provide more detailed information.

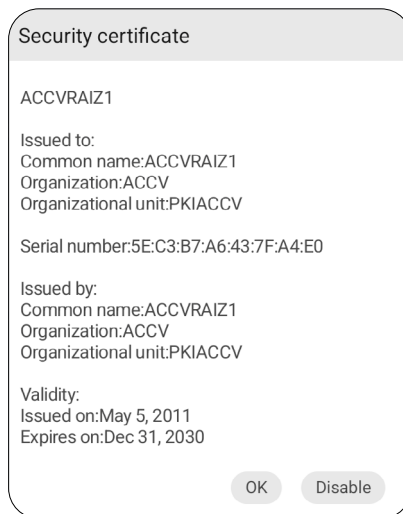

- Allow the installation of applications from unknown sources by selecting the box under **Unknown source security**.

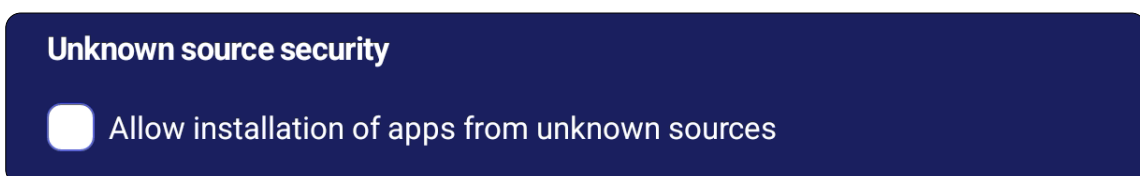

NOTE: Applications from unknown sources may not be compatible or work properly.

System Update

The ViewBoard automatically searches for software updates whenever connected to the Internet (OTA). With just one click, users can update their version of ViewBoard software.

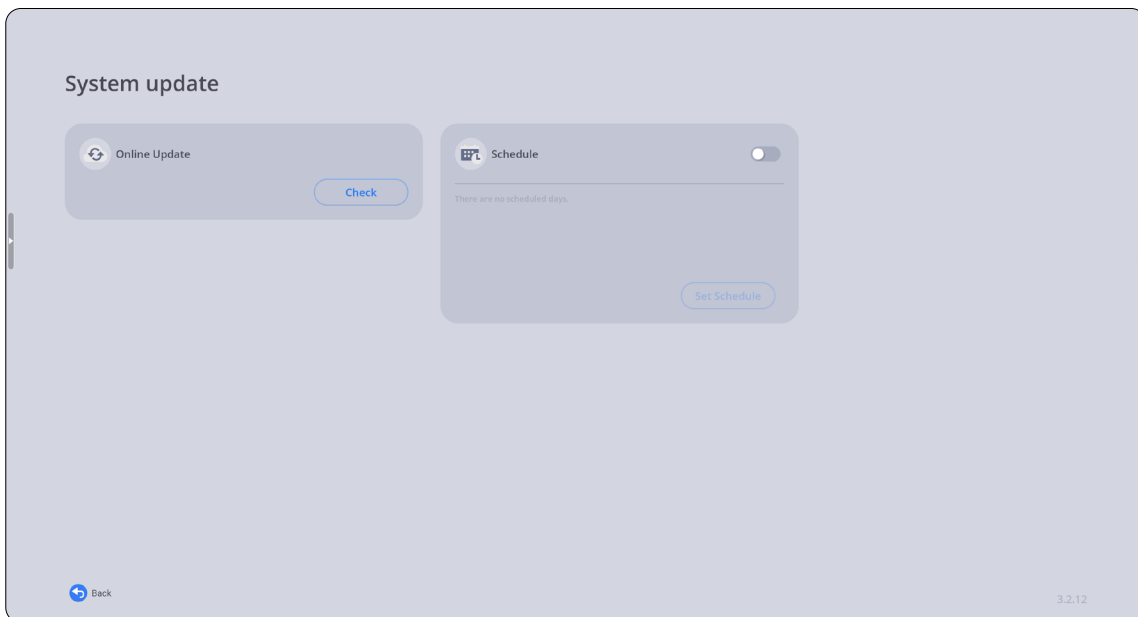

Item	Description
<p>Online Update</p>	<p>Manually check online for a new software version.</p>
<p>Schedule</p>	<p>Set the update time.</p> <div data-bbox="678 1137 1310 1518" style="border: 1px solid black; padding: 10px; margin: 10px auto; width: fit-content;"> <p style="text-align: center;">Schedule Setup</p> <p style="text-align: center;"> 2 17 AM </p> <p style="text-align: center;"> 3 : 18 PM </p> <p style="text-align: center;"> 4 19 </p> <p style="text-align: center;"> <input type="checkbox"/> SUN <input type="checkbox"/> MON <input type="checkbox"/> TUE <input type="checkbox"/> WED <input type="checkbox"/> THU <input type="checkbox"/> FRI <input type="checkbox"/> SAT </p> <p style="text-align: center;"> Cancel Submit </p> </div>

About Device

Display Embedded Player information, **Legal information**, and **Asset Tagging**.

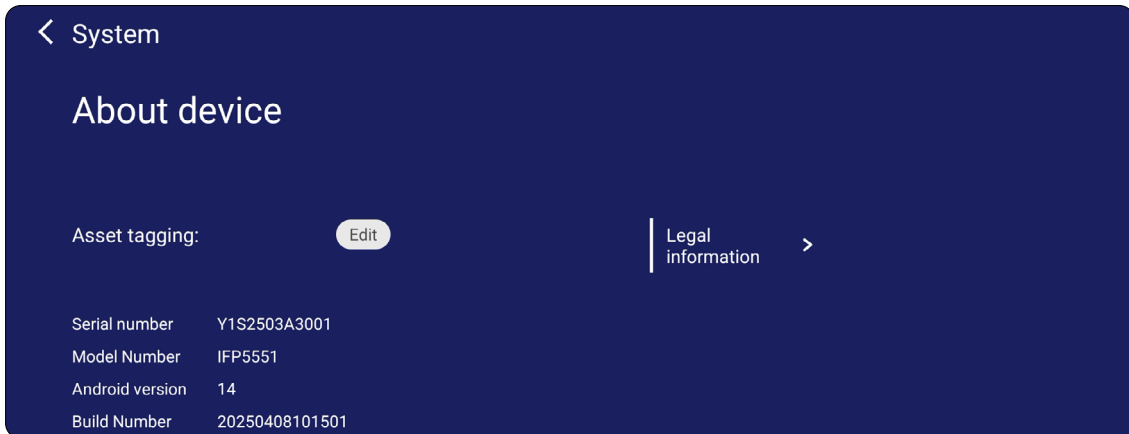

- By selecting **Edit**, the asset information can be adjusted.

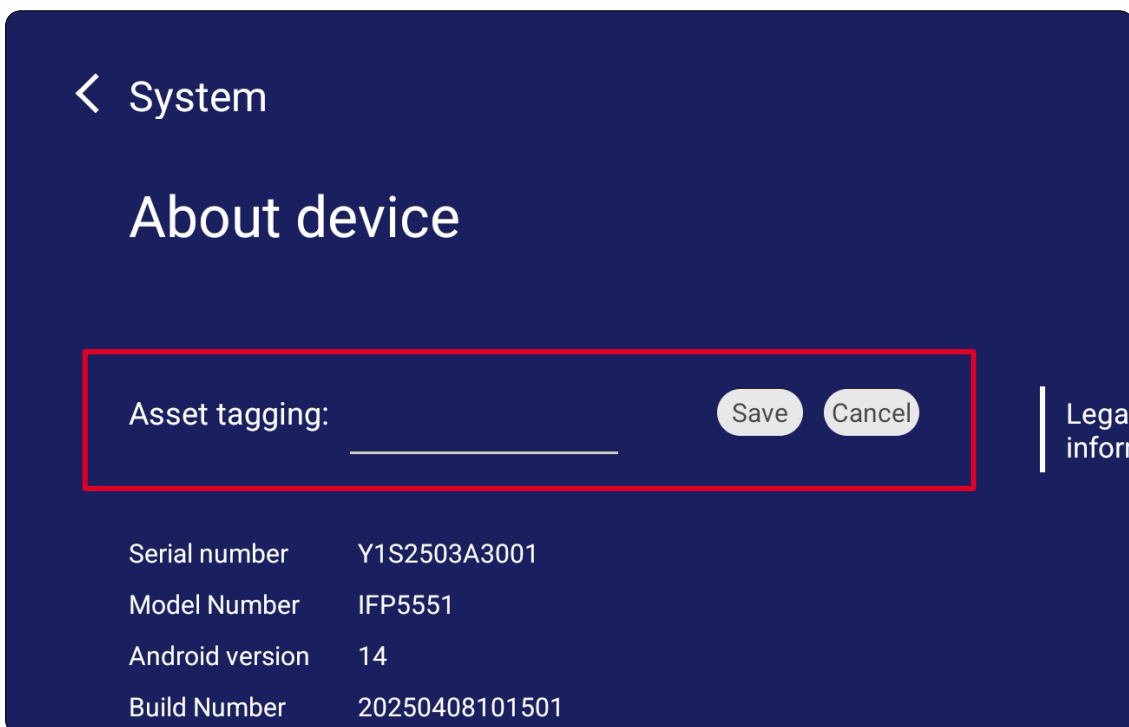

- Tap on **Legal information** to check open source licenses.

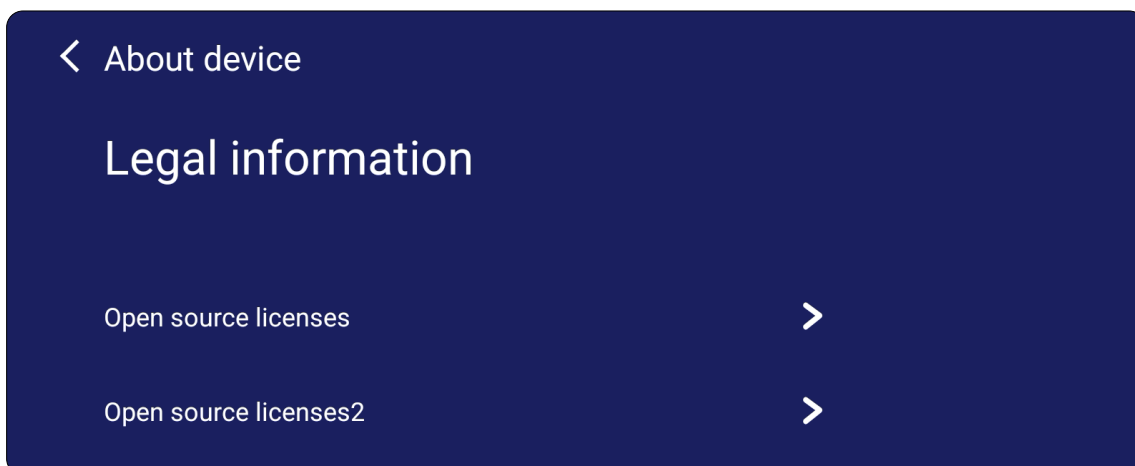

Android Launcher

Network & Internet

Check current connection status, set up and manage Wi-Fi, Ethernet, **VPN**, and **Wireless hotspot**.

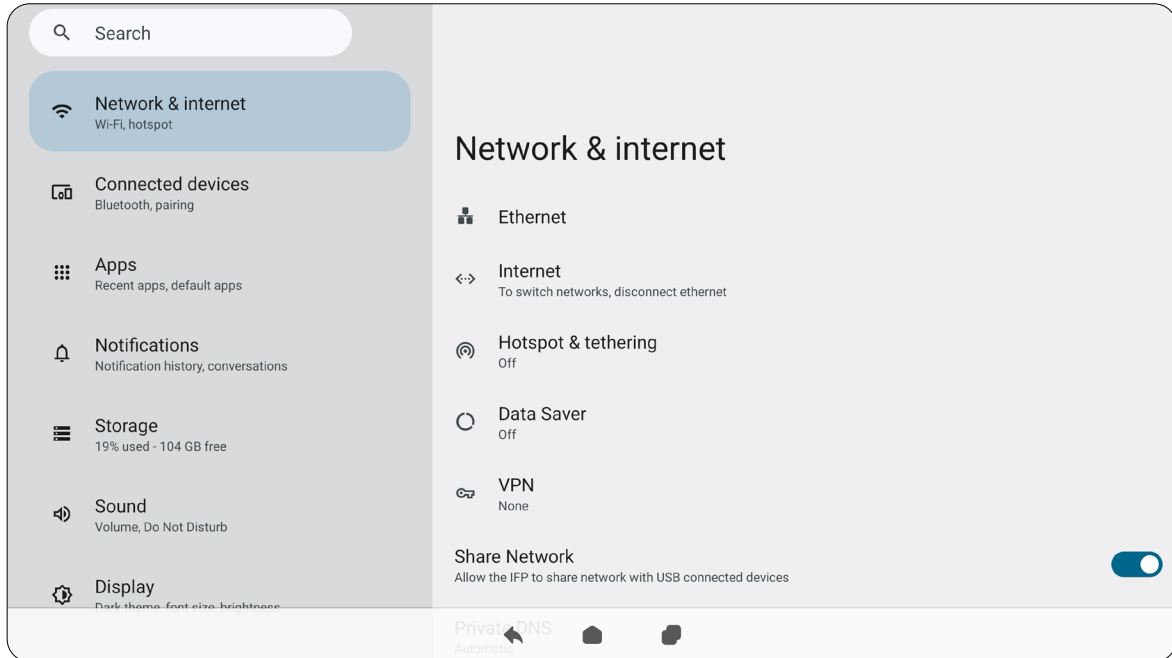

Item	Description
Ethernet	Set the Ethernet network settings.
Internet	Set up and manage Ethernet and Wi-Fi connection, as well as Network preferences.
Airplane Mode	When enabled, all wireless communication will be turned off.
Hotspot & Tethering	Set and share your internet connection with other devices.
Data Saver	When enabled, most apps and services will get background data via an internet connection. Active apps will not be affected.
VPN	Set up and manage Virtual Private Networks.
Share Network	Enable to share the network with other USB connected devices.

Item	Description
Private DNS	Maintain an Automatic Private DNS or set one up manually for security and privacy.

NOTE:

- Wi-Fi, Hotspot, and Bluetooth settings will appear when an optional Wi-Fi card (e.g., VB-WIFI-005) has been installed in the Wi-Fi Slot.
- Ethernet will take priority when both Ethernet and Wi-Fi are enabled.
- The device can connect to the Internet when Hotspot is enabled.

Connected Devices

Set up and manage Bluetooth connections, saved devices, and connection preferences for Bluetooth, Casting, and Print Services.

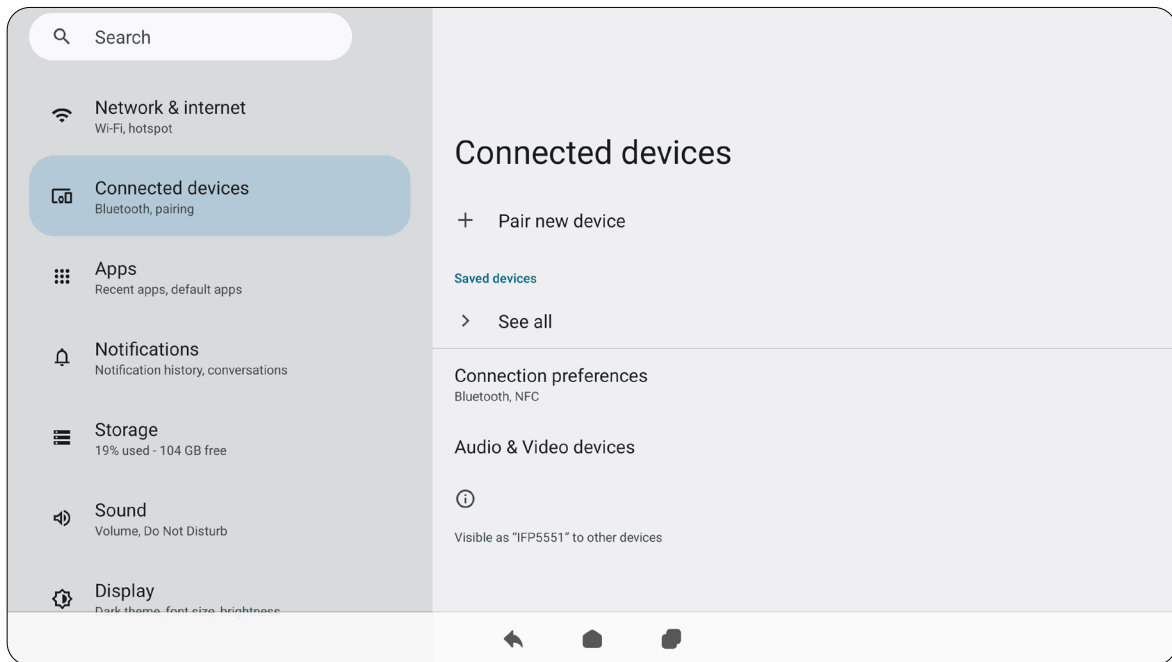

Item	Description
Pair New Device	Enable Bluetooth to search for and connect to a Bluetooth device.
Saved Devices	View all previously connected Bluetooth devices. NOTE: Bluetooth will turn on.
Connection Preferences	View Bluetooth, Cast, and Print Service preferences and share files with nearby devices.
Audio & Video Devices	View all USB connected devices.

Apps

View any running or installed applications. Tap on them for more detailed information and options.

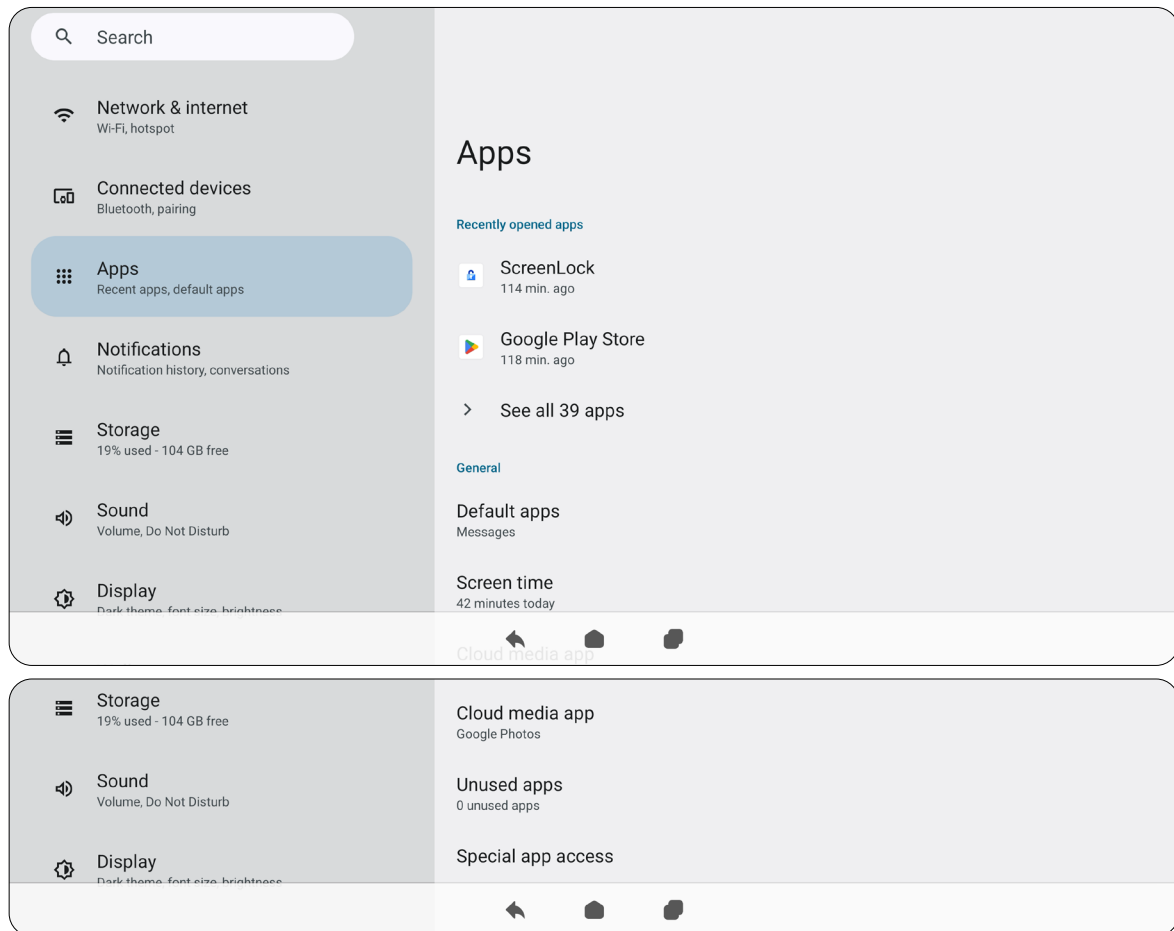

Item	Description
Recently Opened Apps	Any recently used applications will be listed here.
Default Apps	Set default applications for certain uses (e.g., default browser application).
Screen Time	Displays the total amount of time the ViewBoard has been in use by the day.
Cloud Media App	Set your cloud media items (e.g., photos, videos, etc.) locally on the ViewBoard.
Unused Apps	Applications that have not been used for a certain period of time will be listed here.
Special App Access	Set several access permissions for applications.

Notifications

Manage notification and conversation settings and preferences.

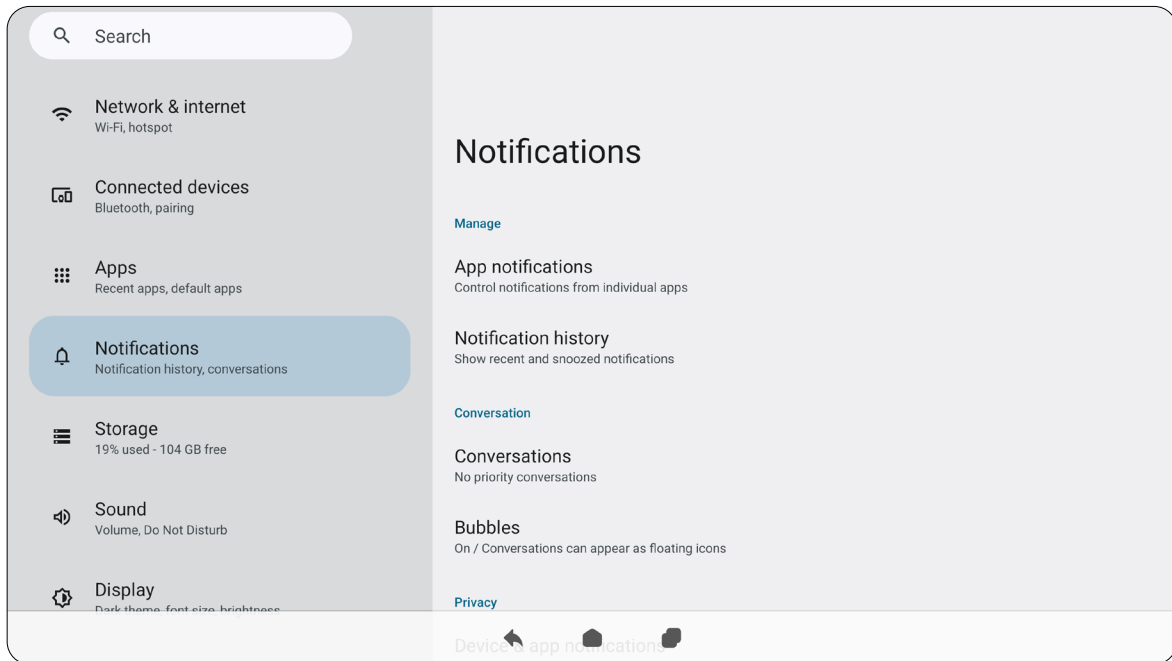

Item	Description
App Notifications	Set up notification settings for individual applications.
Notification History	View recent notifications.
Conversations	Set previously received notifications or messages as priority.
Bubbles	When enabled, conversations can appear as a floating icon on screen.
Device & App Notifications	Control which applications and devices can read notifications.
Notifications on Lock Screen	Choose to show all, some, or no conversations or notifications on the lock screen.
Do Not Disturb	Set notification preferences for when “Do Not Disturb” mode is turned on.
Flash Notifications	Set the screen or camera to light up every time a notification comes in.

Item	Description
Wireless Emergency Alerts	Choose to receive or not receive Emergency Alerts.
Hide Silent Notifications in Status Bar	When enabled, notifications that have been “silenced” will no longer appear in the status bar area.
Allow Notification Snoozing	When enabled, notifications can be “snoozed” for a short period of time for applications.
Notification Dot on App Icon	When enabled, a small dot will appear on the application icon when there is a new notification available.
Enhanced Notifications	When enabled, receive suggestions for actions, replies, etc.

Storage

Check the storage status of the ViewBoard.

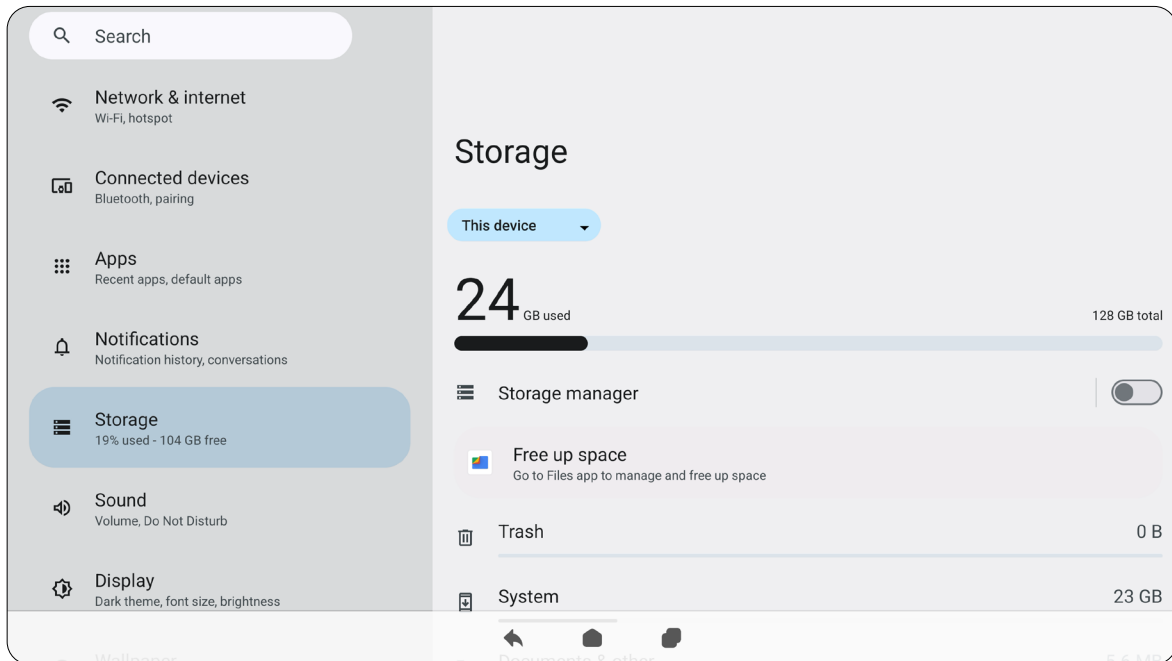

Item	Description
Storage Manager	When enabled, the storage manager will remove backed up photos and videos.
Trash	View and manage files that have been moved to the Trash.
System	View the total storage space of system files.
Documents & Other	View and manage the Documents folder.
Games	View and manage the storage space used by gaming applications.
Apps	View and manage the storage space used by applications.
Audio	View and manage the Audio folder.
Videos	View and manage the Video folder.
Images	View and manage the Images folder.

Sound

Adjust the volume level and set up various sound preferences.

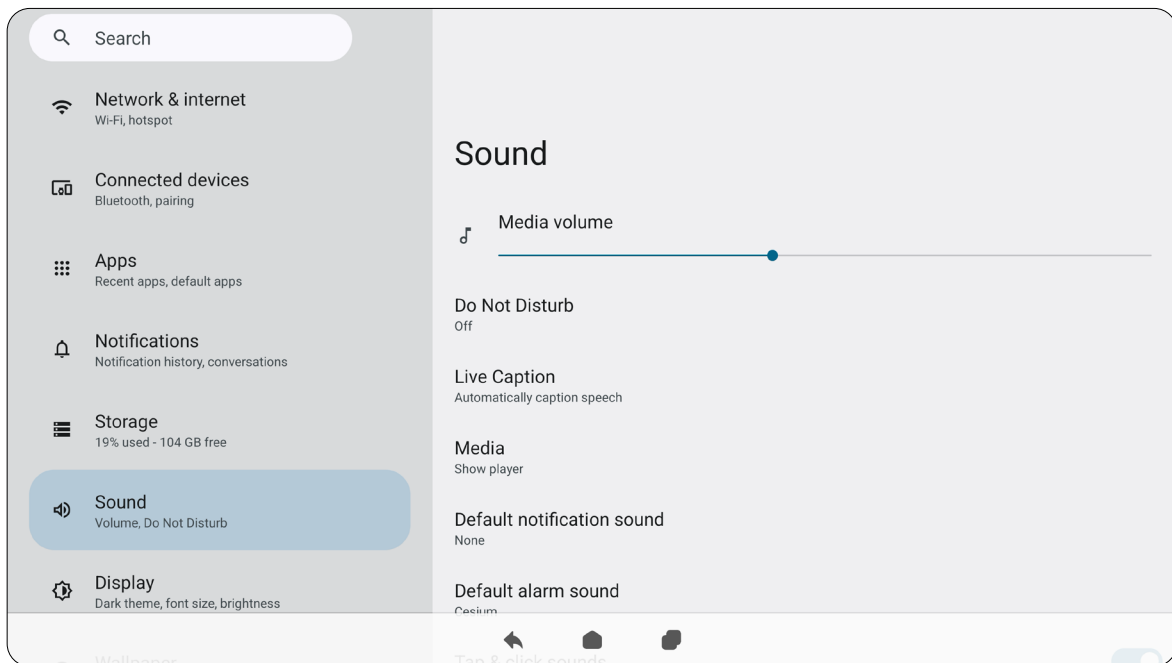

Item	Description
Media Volume	Adjust the volume level.
Do Not Disturb	Set sound preferences for when “Do Not Disturb” mode is turned on.
Live Caption	When enabled, automatically caption.
Media	Set the media player preferences.
Default Notification Sound	Choose the default sound effect for notifications.
Default Alarm Sound	Choose the default sound for alarms.
Tap & Touch Sounds	When enabled, a sound effect will play every time a touch or tap input is received.

Display

Adjust Brightness, Timeout, Theme, HDMI CEC, and other display related settings.

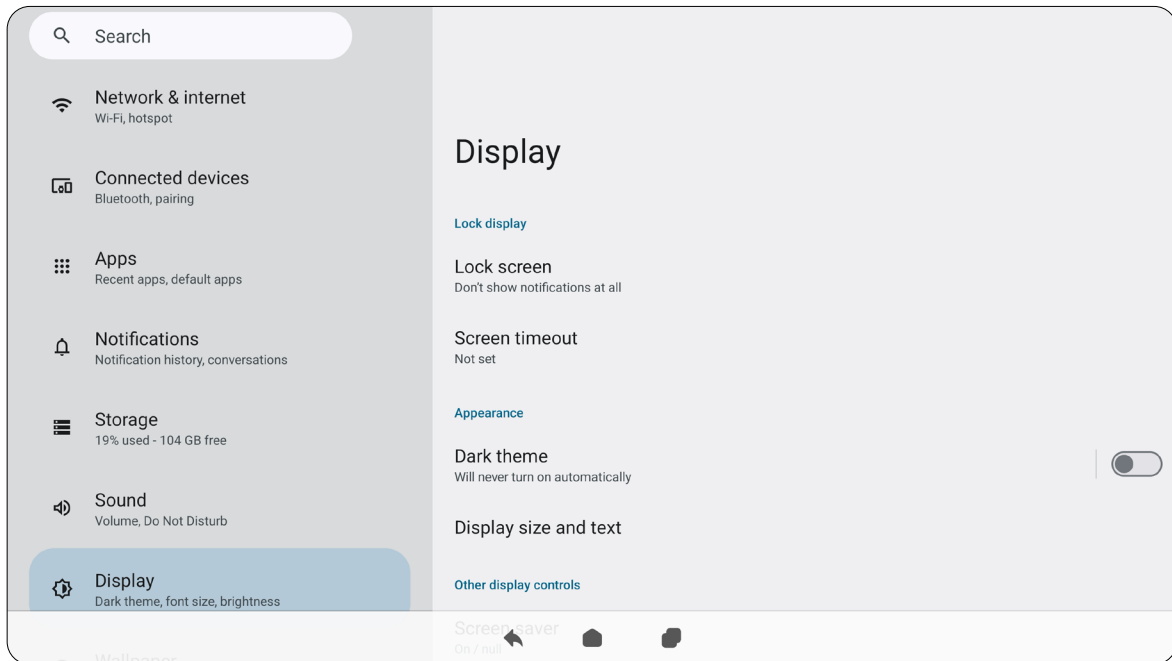

Item	Description
Lock Screen	Set lock screen preferences.
Screen Timeout	Set when the screen will lock after a period of inactivity.
Dark Theme	When enabled, the brighter default background color will be changed to a darker one.
Display Size and Text	Adjust the overall display size or only the text size.
Screen Saver	When enabled, a screen saver will play when the ViewBoard is not in use.

Wallpaper & Style

Adjust and personalize the Wallpaper, Colors and theme of the ViewBoard.

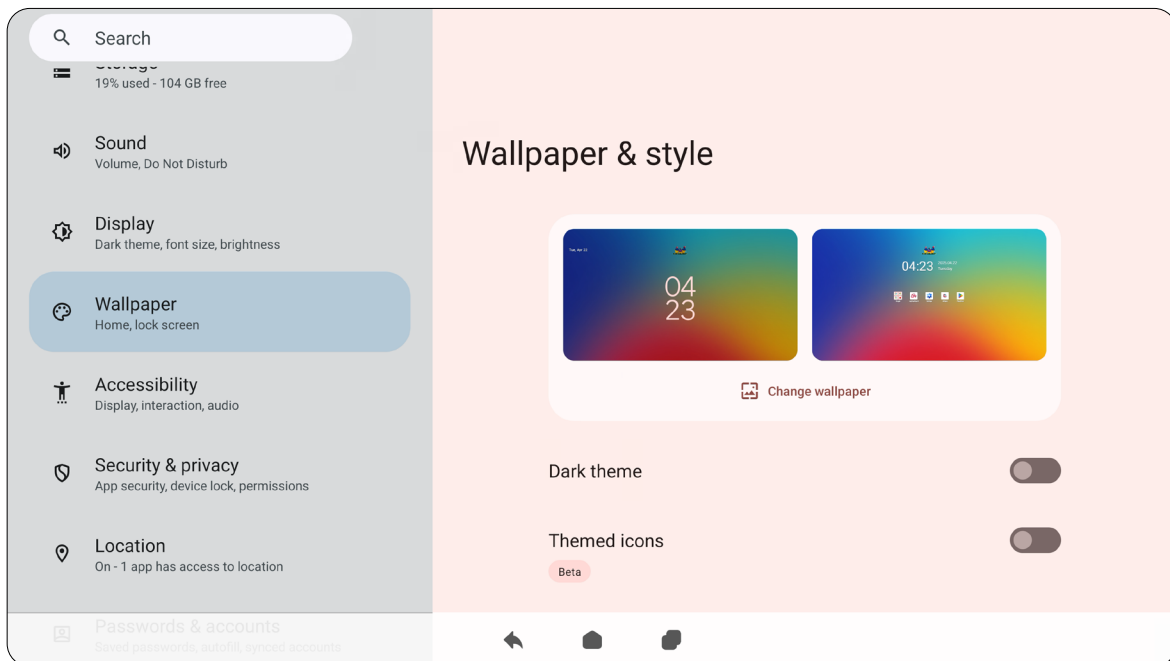

Item	Description
Change Wallpaper	Select a wallpaper for the background.
Dark Theme	When enabled, the brighter default background color will be changed to a darker one.
Themed Icons	Set a set of icons that match the style of the application icons on the Home Screen with your wallpaper.

Accessibility

View and adjust various tools that can help people with visual, auditory, speech, or physical disabilities use the ViewBoard.

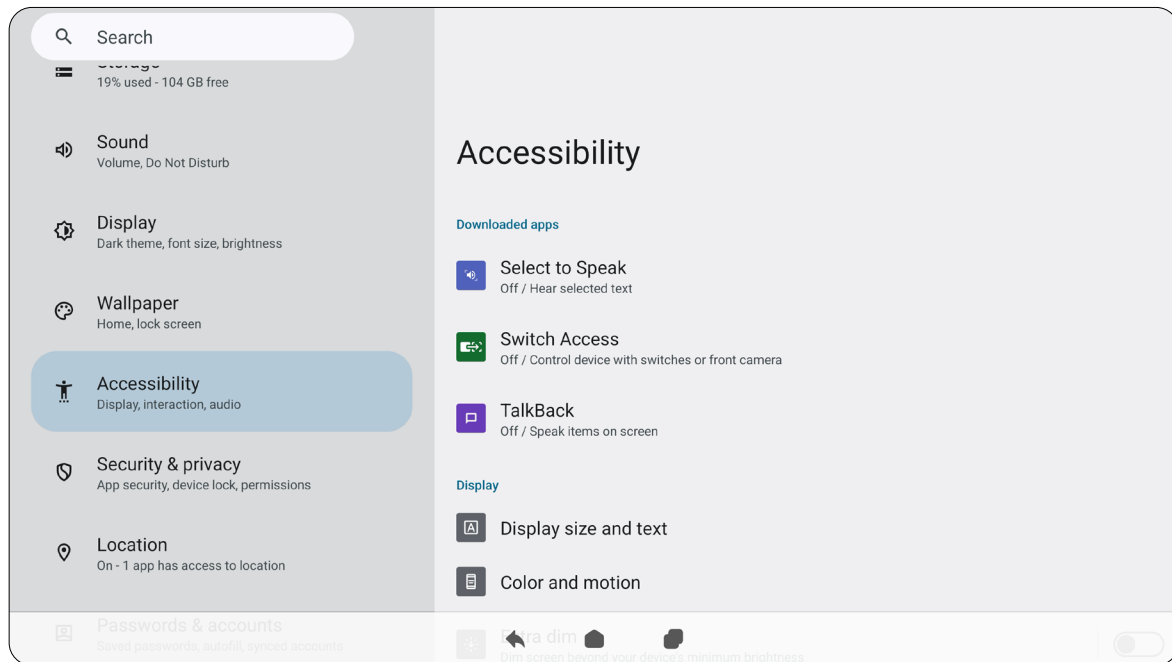

Item	Description
Select to Speak	When enabled, certain on-screen items will be read or described aloud when tapped (e.g., text or image).
Switch Access	Allows the use of one or more switches (e.g., keyboard, controller, etc.) to control the ViewBoard.
TalkBack	When enabled, device actions will be described by audio so it can be used without looking at the screen.
Display Size and Text	Adjust the overall display size or only the text size.
Color and Motion	Apply color correction and inversion and enlarge the mouse pointer.
Extra Dim	Dim the screen for a more comfortable viewing experience.
Magnification	Zoom in on the screen to enlarge the content.
Accessibility Menu	Add a shortcut for an enlarged on-screen menu to control the device.

Item	Description
Timing Controls	Adjust how long temporary messages that ask for an action are on screen, enable Autoclick, and adjust the touch and hold delay time.
System Controls	Adjust the way to navigate the system.
Live Caption	Set the live caption preferences.
Caption Preferences	Enable captions and adjust the size and style.
Audio Description	When enabled, an audio description of what is happening on screen in supported movies and shows will be given.
Flash Notifications	Set the screen or camera to light up every time a notification comes in.
Audio Adjustment	Combine audio channels into a single mono channel.
Accessibility Shortcuts	Adjust the shortcut settings and availability on the lock screen.
Text-to-Speech Output	When set up, text can be read out loud.

Security & Privacy

Review and adjust device security and privacy settings.

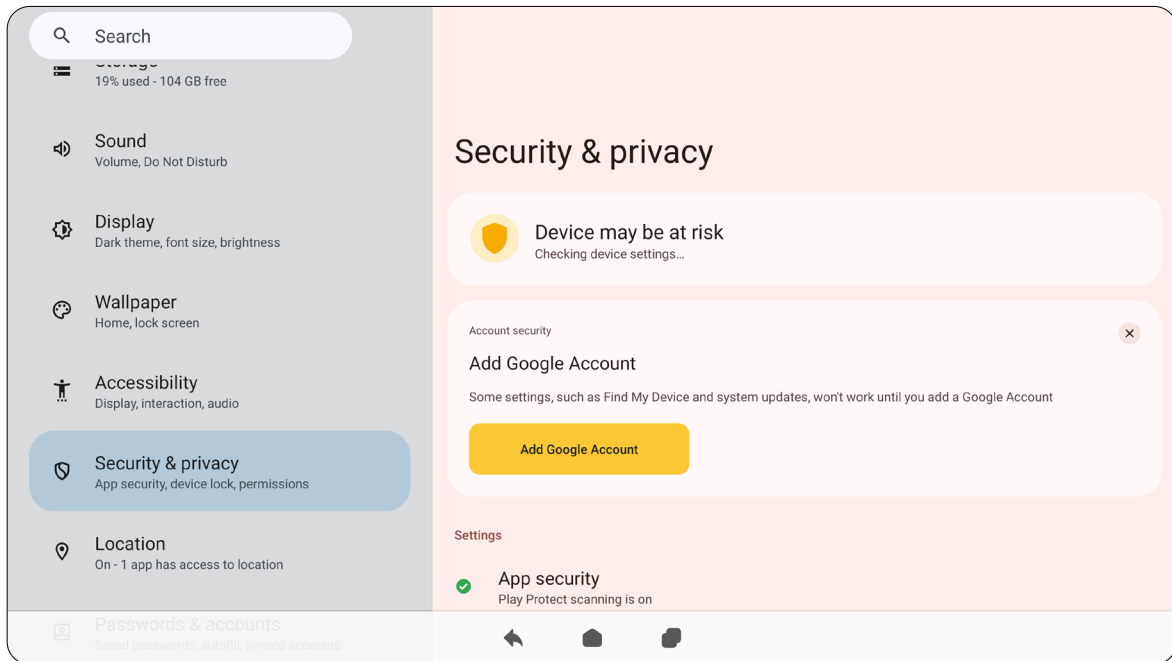

Item	Description
Device May Be at Risk	Scans regularly if the ViewBoard is safe from any harmful behaviors. Recommendations, and actions, will also be given to enhance the overall security and privacy.
Add Google Account	Add, remove, and manage your Google accounts linked to your ViewBoard.
App Security	Manage permissions for installed applications.
Device Unlock	Set the preferred options to lock/unlock the ViewBoard.
Account Security	Manage security permissions for all accounts on the ViewBoard.
Device Finders	Locate the ViewBoard remotely.
System & Updates	Check for system and security updates.
Privacy	Manage application access to your data (e.g., location or camera permissions, etc.)
More Security & Privacy	View and adjust additional security and privacy settings.
More Security Settings	View and adjust various security-related settings.

Location

View and manage location settings.

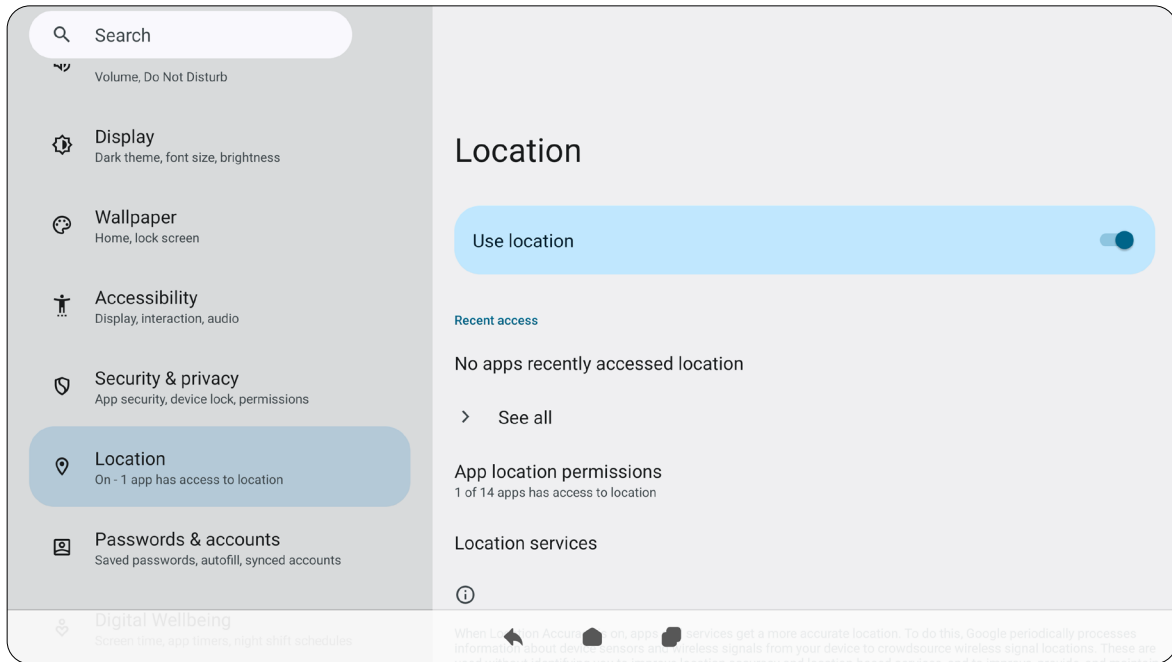

Item	Description
Use Location	When enabled, the location of the device will be accessible to applications.
Recent Access	Review which applications recently accessed the device's location.
App Location Permissions	Review which applications have permission to access the device's location.
Location Services	Turn ON/OFF various alerts, services, and scanning related to location and location accuracy.

Passwords & Accounts

Review saved passwords, select autofill services, and add accounts.

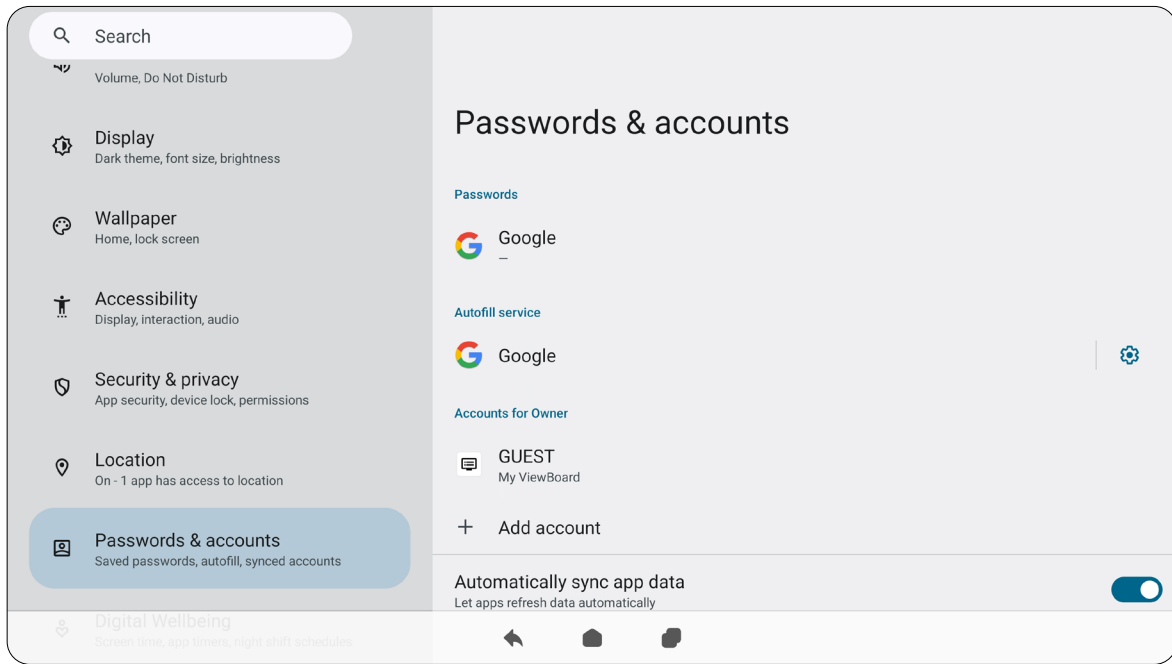

Item	Description
Passwords	Review saved passwords.
Autofill Service	Select which autofill service to use, if any.
Accounts for Owner	Add or remove accounts.
Automatically Sync App Data	When enabled, applications can refresh data automatically.

Digital Wellbeing

Review the ViewBoard’s usage time, and set up various tools to promote a better balance with the device.

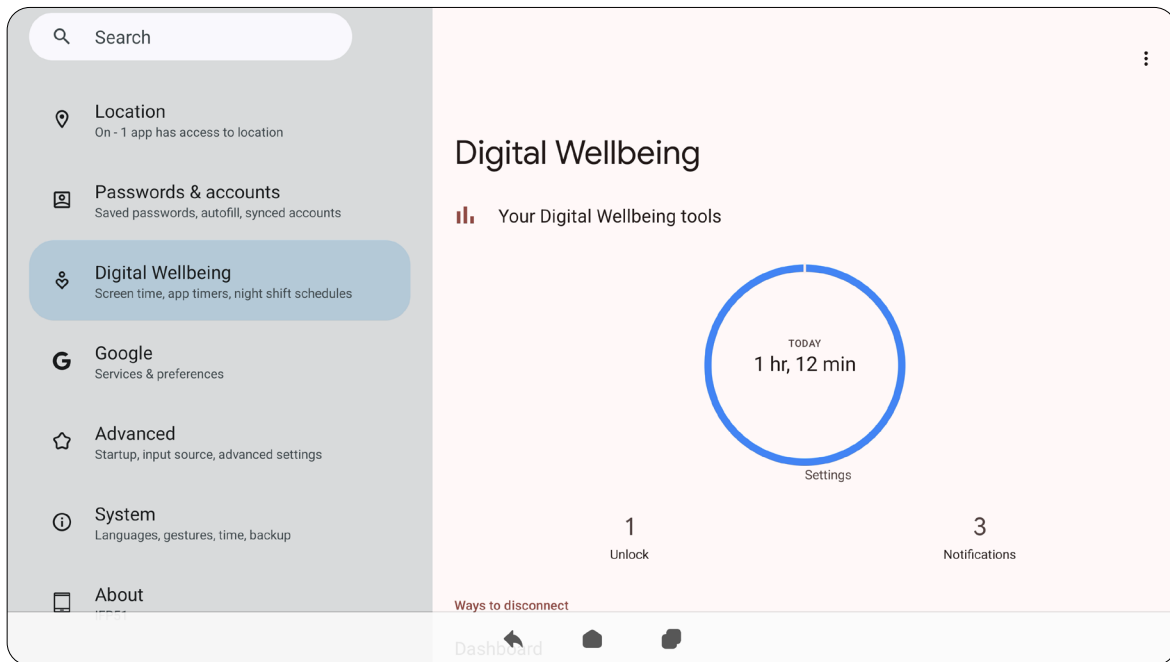

Item	Description
Your Digital Wellbeing Tools	A brief overview of device usage, unlocks, and notifications.
Dashboard	Review screen time, number of notifications, and number of device unlocks.
Night Shift	Reduce the amount of blue light emitted by the ViewBoard’s screen.
Manage Notifications	Review which applications can send notifications.
Do Not Disturb	Set notification preferences for when “Do Not Disturb” mode is turned on.
Heads Up	Set notification preferences when you’re moving with the ViewBoard.
Show Icon in the App List	Hide or display the Digital Wellbeing icon from your app list.

Google

Review all of Google's services and set up preferences.

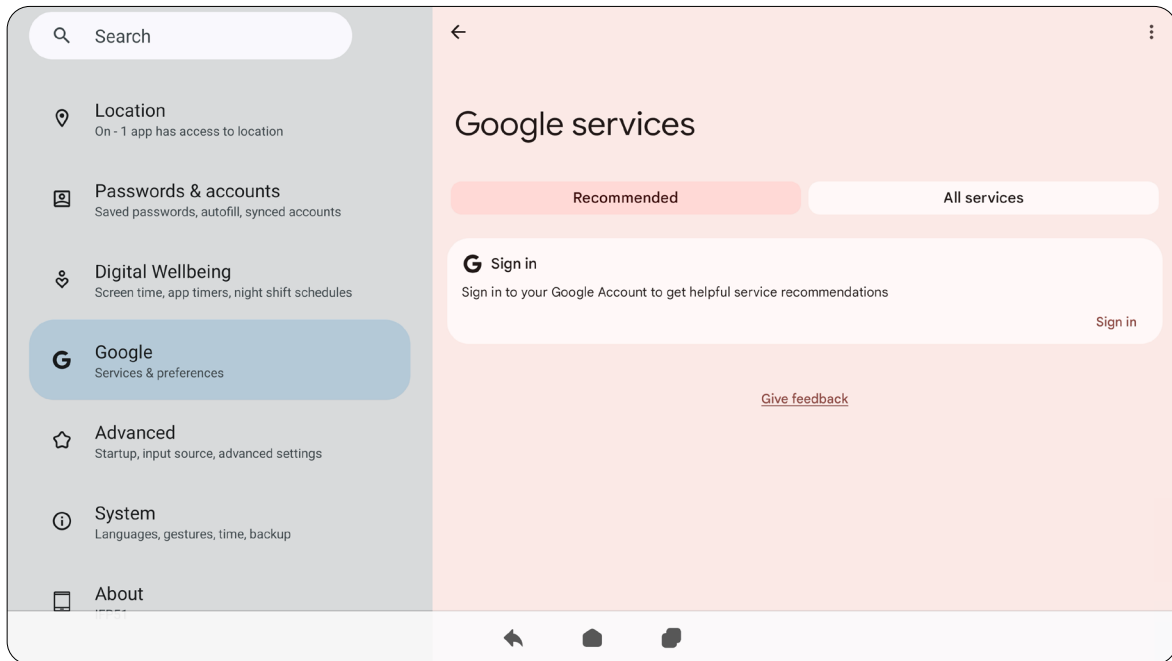

Advanced

View and adjust various system settings.

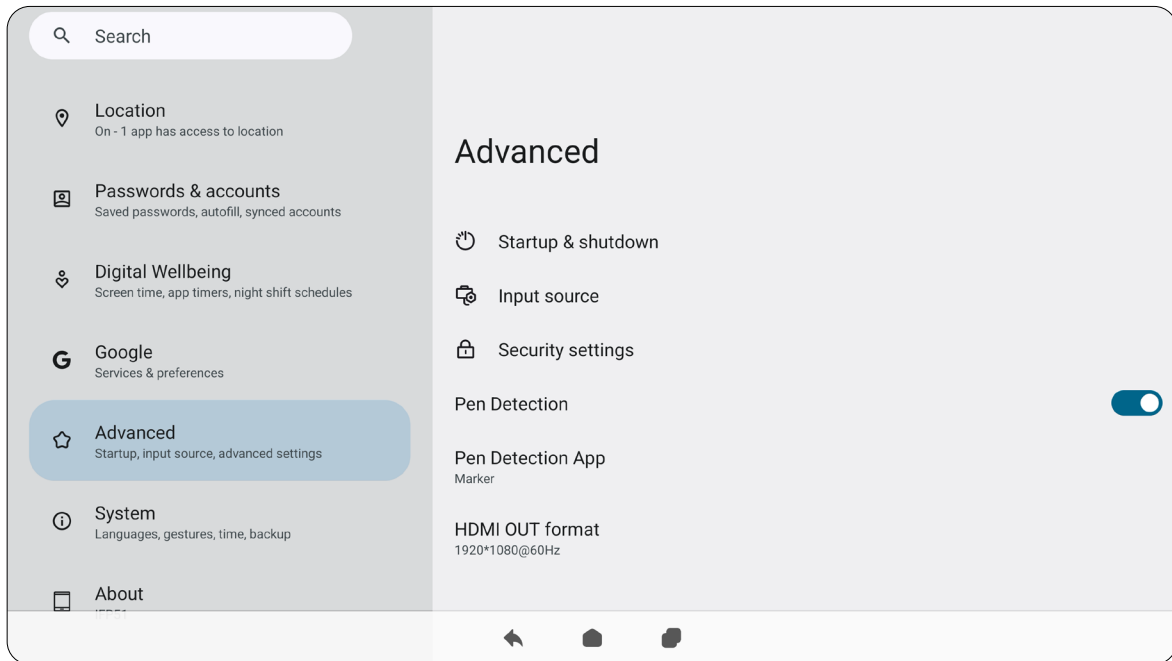

Item	Description
Startup & Shutdown	Set the startup and shutdown settings.
Input Source	Adjust the input source names, HDMI CEC, and other input source settings.
Security Settings	Set a password for the ViewBoard or the advanced settings, or manage the permissions to install applications from unknown sources.
Pen Detection	Enable the Pen detection function.
Pen Detection App	Set the preferred app when the Touch Pen is detected.
HDMI Out Format	Set the preferred HDMI Out Resolution settings.

System

View and adjust various system settings.

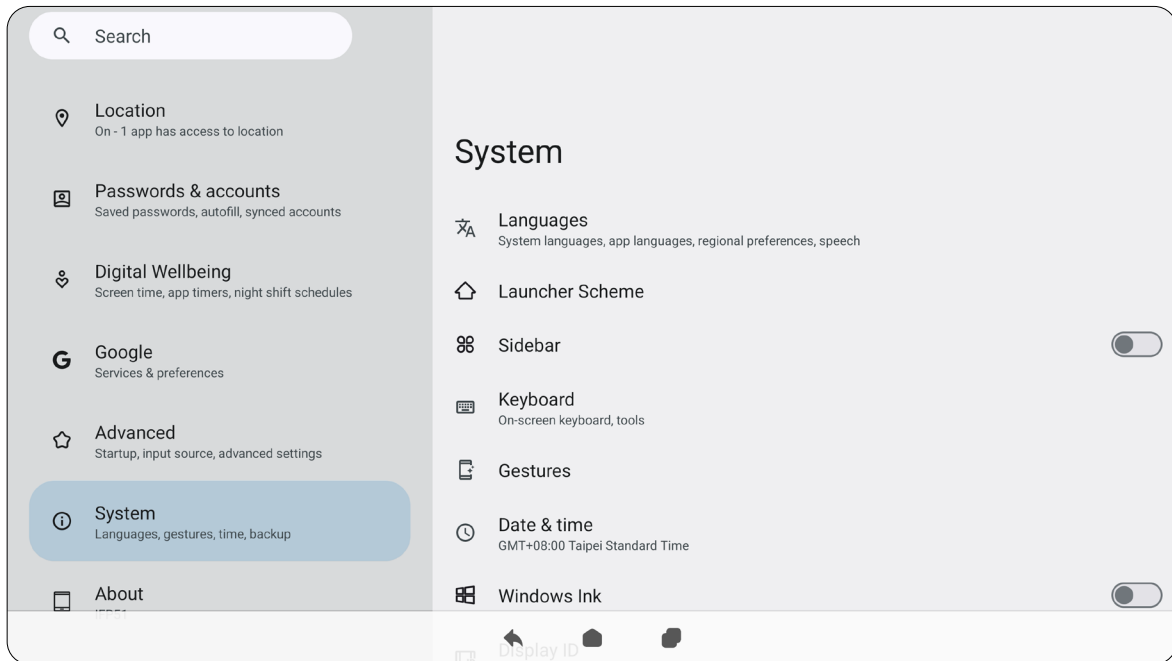

Item	Description
Languages	Choose the preferred language and input method.
Launcher Scheme	Choose between Scheme A and Scheme B to set the Home Screen layout.
Sidebar	Adjust the side toolbar settings.
Keyboard	Enable/disable the visual keyboard and/or change the default input method.
Gesture	Set the preferred touch gestures when using the ViewBoard.
Date & Time	Set the date and time.
Windows Ink	Enable and set up Windows Ink support.
Display ID	Assign a number to remote control the display by RS-232/LAN.
Backup	With a Google account, back up the device's data.
ViewSonic System Update	Check for system updates.
Multiple Users	Review who is signed in and the available user logins.
Reset Options	Reset the ViewBoard to factory default settings.

About Device

Review device information.

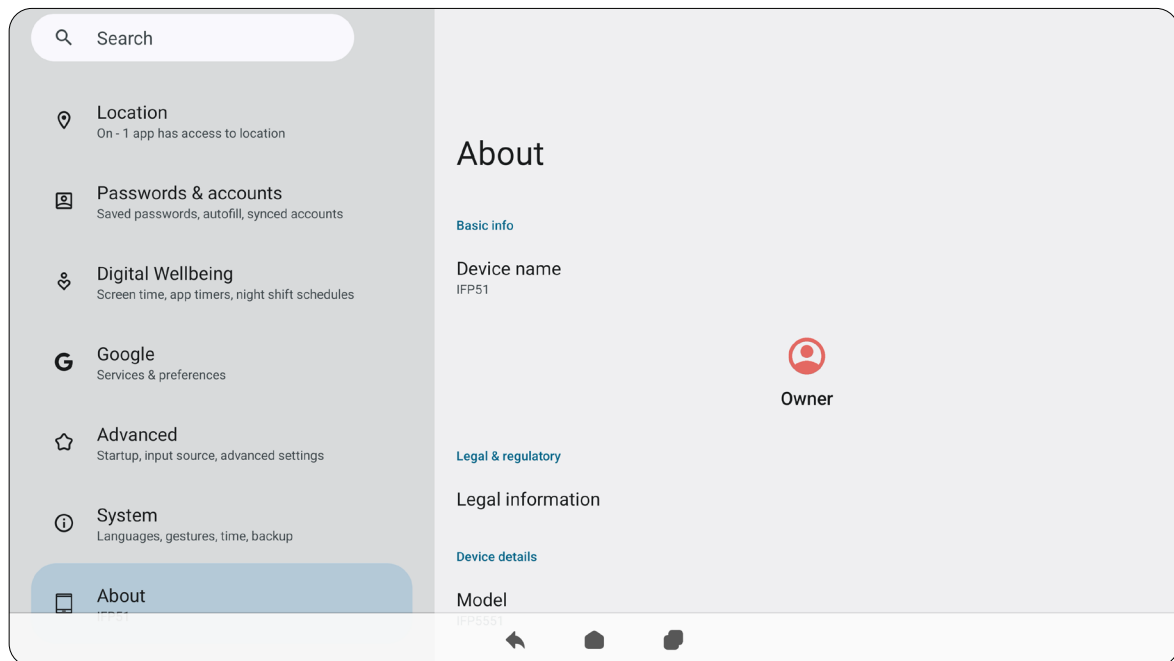

Item	Description
Device Name	View the name of the device.
Legal Information	View the relevant legal information.
Model	View the model of the ViewBoard.
Android Version	View the installed version of Android.
IP Address	View the IP Address.
Ethernet Address	View the Ethernet Address.
Wi-Fi MAC Address	View the Wi-Fi MAC Address.
Device Wi-Fi MAC Address	View the Device Wi-Fi MAC Address.
Bluetooth Address	View the Bluetooth Address.
Up Time	View how long the device has been in operation.
Build Number	View the build number.

Tips & Support

View new features, tips, and get support for the myViewBoard Whiteboard, myViewBoard Display, and myViewBoard Manager applications.

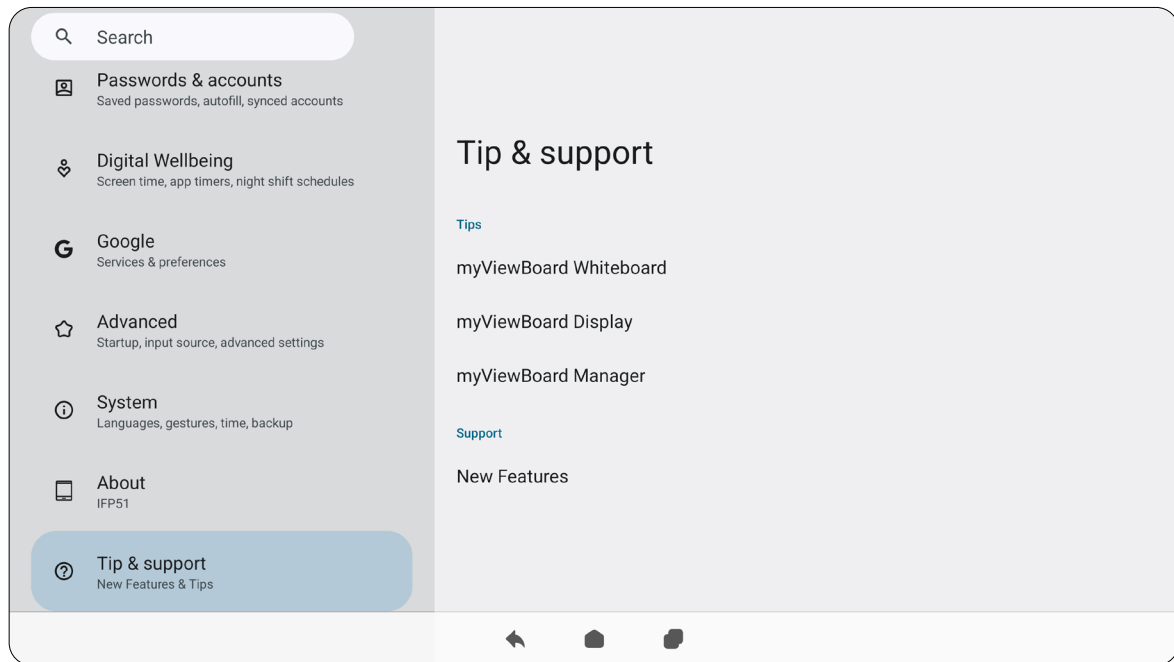

Android Settings Menu Tree

Menu	Sub-menu	Menu Option			
Network & Internet	Ethernet	DHCP			
		Static IP			
		IP Address			
		Dafault gateway			
		Netmask			
		DNS			
		Proxy			
		Mac address			
	Internet	Wi-Fi	Wi-Fi list		
			Add network		
		Network Preferences	Turn on Wi-Fi automatically		
			Notify for public networks		
			Share Wi-Fi only via a QR code		
			Install certificates		Recent
			Wi-Fi direct		
		Saved Networks	Other networks		
		Non-carrier data usage			

Menu	Sub-menu	Menu Option		
Network & Internet	Hotspot & tethering	Wi-Fi hotspot	Use Wi-Fi hotspot	WPA2-Personal
			Hotspot name	
			Security	
			Turn off hotspot automatically	
			Extend compatibility	
	USB tethering	Bluetooth tethering		
	Data Saver	Unrestricted data		
	VPN	VPN+		
		VPN list		
	Shared network			
	Private DNS	Off		
		Automatically		
		Private DNS provider hostname		
		Enter hostname of DNS provider		

Menu	Sub-menu	Menu Option				
Connected Devices	USB	Connected device				
		This device				
		File transfer				
		USB tethering				
		PTP				
		No data transfer				
		Convert video to AVC				
		Charge connected device				
	Pair new device	Device name				
		Available devices				
	See all	Saved devices				
	Connection preferences	Bluetooth	Use NFC Bluetooth			
			Device name			
			Pair new device			
		NFC	Use NFC		Default payment app	
			Contactless payments			Use default payment app
			Cast			Cast list
		Printing	Default print Service			
			Add service			
		Quick share	Account			
			Device name			
			Who can share with you			

Menu	Sub-menu	Menu Option				
Connected Devices	Audio & video devices	Camera				
		Mic	Auto			
			Off			
			USB-audio touch device			
		Mic	Auto			
			Speaker			
			HDMI out			
		Speaker				
		Apps	Recently opened apps	App list	App info	
					Notifications	
Permissions	Location					
	Phone					
	Camera					
	Pause app activity is unused					
Storage & cache	Clear storage/cache					
	App size					
	User data					
	Cache					
	Total					
Mobile data & Wi-Fi	Total					
	Foreground					
	Background					
Screen time	App timer					
	Manage notifications					
	App used in the background					

Menu	Sub-menu	Menu Option		
Apps	Recently opened apps	App list	App battery usage	Unrestricted
				Optimized
				Restricted
			Open by default	Open supported links
			Pause app activity if unused	Allow display over other apps
			Display over other apps	
			Modify system settings	Allow modifying system settings
			Version	
	Default apps	Browser app	Default browser app	
		Digital assistant app	Use text from screen	
			Use screenshot	
			Flash screen	
		Home app	Default home app	
		SMS app	Default SMS app	
		Opening links	Instant apps	
	Instant apps preferences			
	Screen time	Activity details		
	Cloud media app			
	Unused apps			

Menu	Sub-menu	Menu Option	
Apps	Special app access	All files access	
		Device admin apps	
		Display over other apps	
		Do not disturb access	
		Media management apps	
		Modify system settings	
		Device & app notification	
		Picture-In-Picture	
		Premium SMS access	
		Unrestricted data	
		Install unknown apps	
		Alarms & reminders	
		Usage access	
		VR helper services	
		Wi-Fi control	
		Turn screen on	
Full screen notification			

Menu	Sub-menu	Menu Option	
Notifications	App notifications	App list	Screen lock
			All Google Play store notification
			All "Alerts" notifications
			Account
			App auto open
			Open app reminders
			Payments, Deals, and Recommendations
			Updates available
			Updates completed
			All "Essentials" notifications
			Maintenance
			Play Protect
			required
			Security and errors
	Setup		
		All notification dot	
		Notification history	Use notification history
		Conversations	
		Bubbles	Allow apps to show bubbles
		Device & app notifications	Allowed
	Not allowed		

Menu	Sub-menu	Menu Option				
Notifications	Notifications on lock screen	Show conversations, default, and silent				
		Hide silent conversations and notification				
		Don't show any notifications				
	Sensitive notifications					
	Do not disturb	Turn on now				
		People			Messages	Starred contact
						Contacts
						Priority conversations
						Anyone
						None
		People	Calls	Starred contact		
				Contacts		
				Anyone		
				None		
				Allow repeat callers		
		Apps	Apps			
Add apps						
Alarms & other interruptions	Alarms					
	Media sounds					
	Touch sounds					
	Reminders					
	Calendar events					

Menu	Sub-menu	Menu Option		
Notifications	Do not disturb	Schedules	Sleeping	User schedule
				Days
				Start time
				End time
				Alarm can override end time
				Do Not Disturb behavior
			Event	User schedule
				During events for
				Where reply is
				Do not disturb behavior
			Add more	
			Duration for quick settings	
		For 1 hour		
		Ask every time		
		Display options for hidden notification	No sound from notification	
			No visuals or sound from notification	
			Custom	Don't turn on screen
		Don't wake for notifications		
		Hide notification dots on app icons		
		Hide status bar icons at top of screen		
		Don't pop notifications on screen		
Hide from pull-down shade				

Menu	Sub-menu	Menu Option			
Notifications	Flash notifications	Screen flash			
		Preview			
	Wireless Emergency Alerts				
	Hide Silent Notifications in Status Bar				
	Allow Notification Snoozing				
	Notification Dot on App Icon				
Enhanced Notifications	User storage manager				
Storage	Storage manager	Remove photos & videos	Over 30 days old		
			Over 60 days old		
			Over 90 days old		
	Trash				
	System				
	Apps				
	Documents & other				
	Games				
	Apps				
	Audio				
	Videos				
	Images				

Menu	Sub-menu	Menu Option		
Sound	Media volume			
	Do not disturb	People	Messages	Starred contacts
				Contacts
				Priority conversations
				Anyone
				None
			Calls	Starred contacts
		Contacts		
		Anyone		
		None		
		Apps	Apps	
			Add apps	
		Alarms & other interruptions	Alarms	
	Media sounds			
	Touch sounds			
	Reminders			
	Calendar events			

Menu	Sub-menu	Menu Option		
Sound	Do not disturb	Schedules	Sleeping	User schedule
				Days
				Start time
				End time
				Alarm can override end time
				Do Not Disturb behavior
			Event	User schedule
				During events for
				Where reply is
				Do not disturb behavior
		Add more		
		Duration for quick settings		Until you turn off
				For 1 hour
				Ask every time
		Display options for hidden notification		No sound from notification
				No visuals or sound from notification
		Custom		Don't turn on screen
				Don't wake for notifications
				Hide notification dots on app icons
				Hide status bar icons at top of screen
			Don't pop notifications on screen	
Hide from pull-down shade				

Menu	Sub-menu	Menu Option	
Sound	Live caption	Use Live Caption	
		Language	(English only)
		Hide profanity	
		Show sound labels	
		Live Caption in volume control	
		Help	
	Media	Pin media player	
		Show media on lock screen	
		Show media recommendations	
	Default notification sound	None	
		Adara/Aldebaran/Selenium/...	
		Add notification	

Menu	Sub-menu	Menu Option	
Sound	Default alarm sound	None	
		Argon	
		Barium	
		Bee-Beep alarm	
		Beep-Beep-Beep alarm	
		Buzzer alarm	
		Cabon	
		Cesium	
		Heium	
		Krypton	
		Neon	
		Neptunium	
		Osmium	
		Oxygen	
		Piezo alarm	
		Platinum	
		Platinum	
		Rooster alarm	
		Scandium	
	Add alarm		
Tap & click sounds			

Menu	Sub-menu	Menu Option	
Display	Lock screen	Privacy	Show all notification content
			Show sensitive content only when unlocked
			Don't show notifications at all
		Add users from lock screen	
		Add text on lock screen	
		Show device controls	
		Use device controls	
		Dynamic clock	
		Wake screen for notifications	
		Double-line clock	
	Screen timeout	15 seconds	
		30 seconds	
		1 minute	
		2 minutes	
		5 minutes	
		10 minutes	
		30 minutes	

Menu	Sub-menu	Menu Option	
Display	Dark theme	Use dark theme	
		Schedule	None
			Turns on at custom time
			Turns on from sunset to sunrise
			Turns on bedtime
	Display size and text	Font size	
		Display size	
		Bold text	
		High contrast text	
		Reset settings	
	Screen saver	Use Screen Saver	
		Screen saver	Never
			15 min
			30 min
			60 min
			90 min
		Choose a screen saver	Clock
			Colors
			Photos frame
			Photo table
Photo			

Menu	Sub-menu	Menu Option			
Wallpaper & Style	Wallpaper	Home screen			
		Lock screen			
	Change wallpaper	My Photos	Select a photo		
		On-device wallpapers	Preview		
		Cityscapes			
		Life			
		Textures			
		Landscapes			
		Art			
		Earth			
		Solid colors			
		Geometric shapes			
		Seascape			
		Wallpapers			
	Dark theme				
	Themed icons				

Menu	Sub-menu	Menu Option				
Accessibility	Select to speak	Select to speak shortcut				
		Settings	Text to speech settings	Preferred engine		
				Language		
				Speech rate		
				Pitch		
			Change reading voice			
			Read in background			
			Read text on images			
		Help & feedback	Popular help resources			
		Developer settings	Enable taking snapshot			
			Allow snapshot to take detail information			
		Switch access	Use Switch Access	Choose a switch type		
			Switch Access shortcut			

Menu	Sub-menu	Menu Option		
Accessibility	Switch access	Settings	Help & feedback	Popular help resources
			Open setup guide	Choose a switch type
			Camera switch settings	Use camera switches
				Open mouth
				Smile
				Raise eyebrows
				Look left
				Look right
				Look up
				Enhanced visual feedback
				Enhanced audio feedback
				Keep screen on
				Ignore repeated camera switch triggers
			Assign switches for scanning	Pause camera Switch
				Auto-scan
				Reverse auto-scan
				Select
				Next
				Previous
				Touch & hold
Scroll forward				
Assign switches to shortcuts	New shortcuts			

Menu	Sub-menu	Menu Option		
Accessibility	Switch access	Settings	Enable menu customization	
			Revert to Default Menu	Restore default menu
			Auto-scan	Auto-scan time
				Delay on first item
				Number of scans
			Scanning method	Linear scanning
				Row-column scanning
				Group selection
			Point scan	Line speed
				Delay on first item
				Number of scans
				Vertical scans
				Horizontal scans
			Automatically start scanning	
			Auto-select	
Scanning highlight style	Highlight color			
	Highlight line style			

Menu	Sub-menu	Menu Option			
Accessibility	Switch access	Settings	Speech, sound & vibration	Spoken feedback	
				Speak descriptive text	
				Verbosity	
				TTS settings	
				Finish speech before moving	
				Maximum spoken time per item	
				Vibration feedback	
				Sound feedback	
				Sound volume	
				Audio ducking	
			Ignore repeated presses		
			Release to perform action		
			Privacy policy		
			Developer settings		Version
					Display speech output
					Delete all shortcuts
					Log output level

Menu	Sub-menu	Menu Option				
Accessibility	TalkBack	Use TalkBack				
		TalkBack shortcut				
		Settings	New features in TalkBack	Verbosity		
			Text-to-speech settings			Preferred engine
						Language
						Speech rate
						Pitch
						Play/Reset
						Choose a preset
						Speak usage hints
						Speak list and grid info
						Always speak number of list items
						Speak element type
						Speak window names
						Speak notifications when screen is off
						Use pitch changes
						Speak letters with examples
						Keyboard echo: On-screen keyboard
						Keyboard echo: Physical keyboard
						Capital letters
Speak all progress updates						
Speak element IDs						
Speak punctuation and symbols						

Menu	Sub-menu	Menu Option		
Accessibility	TalkBack	Settings	Sound	Accessibility volume
				TalkBack speech rate
				Sound feedback
				Sound feedback volume
				Audio ducking
			Customize focus	Thick borders
				Color default
				Red
				Orange
				Yellow
				Green
				Blue
			Customize Gestures	Grey
				Practice gestures
				Reset gesture setting
			Customize menus	Swipe up/Swipe down/Swipe left/...
				Customized TalkBack menu
			Image & icon descriptions	Customized reading controls
				Detailed image descriptions
				Automatic image descriptions
Automatic icon descriptions				
Automatic descriptions for text in image				

Menu	Sub-menu	Menu Option		
Accessibility	TalkBack	Settings	Braille keyboard	Set up braille keyboard
				Review all gestures
				Languages
				Preferred typing language
				Preferred braille grade
				Layout
				Include all pressed dots
				Reverse dots
			Braille display	Use braille display
				Look for new device
				Languages
				Preferred reading language
				Preferred typing language
				Preferred braille grade
				Braille display commands
				Braille elements
				Auto-connect
				Auto-scroll

Menu	Sub-menu	Menu Option						
Accessibility	TalkBack	Settings	Advanced settings	Speak passwords				
				Custom labels				
				Single-tap to activate				
				Element description order				
				Time format				
				Reduce window announcement delay				
				Typing preference				
				Touch and hold delay when typing				
				Keyboard shortcut				
				Developer settings				
				Privacy policy				
				Terms of service				
				Display size and text	Font size			Open Talkback at the Play Store
								TalkBack tutorial
	Help & feedback							
	Contact Google disability support							
	Display size and text	Font size						
		Display size						
		Bold text						
High contrast text								
Reset settings								

Menu	Sub-menu	Menu Option			
Accessibility	Color and motion	Color correction	Use color correction		
			Red-green		
			Red-green		
			Blue-yellow		
			Grayscale		
			Color correction shortcut		
		Color inversion	Use color inversion		
			Color inversion shortcut		
		Dark theme	Use dark theme		None
			Schedule		Turns on a custom time
	Turns on from sunset to sunrise				
	Turns on at bedtime				
	Large mouse pointer				
	Extra dim	Make screen extra dim			
		Intensity			
Keep on after device restarts					
Extra dim shortcut					

Menu	Sub-menu	Menu Option	
Accessibility	Magnification	Magnification shortcut	
		Magnification type	Magnify full screen
			Magnify part of screen
		Magnify typing	
		Keep on while switching apps	
	Accessibility menu	Accessibility Menu shortcut	
		Settings	Large button
			Help & feedback
	Time controls	Touch & hold delay	Short
			Medium
			Long
		Time to take action	Default
			10 seconds
			30 seconds
			1 minute
			2 minutes
		Autoclick	Autoclick off
			Short
			Medium
Long			
Custom			

Menu	Sub-menu	Menu Option			
Accessibility	System controls	Navigation mode	Gesture navigation	Swipe to invoke assistant	
				Left edge	
				Right edge	
				Hold Home for Assistant	
			3-button navigation		
			Side toolbar navigation		
	Live caption	Use live caption	Languages		
			Hide profanity		
			Show sound labels		
			Live caption in volume control		
			Help		
			More options		
	Caption preferences	Caption size and style	Show captions		
			Text size	Very small	
				Small	
				Medium	
				Large	
				Very large	
			Caption style	Set by app	
				White on black	
				Black on white	
Yellow on black					
Yellow on blue					
Custom					
More options			Languages		

Menu	Sub-menu	Menu Option								
Accessibility	Audio description									
	Flash notifications	Screen flash								
		Preview								
	Audio adjustment	Mono audio								
	Accessibility shortcuts	Accessibility button	Location	Floating over other apps						
				Navigation bar						
			Size	Small						
				Large						
			Fade when not in use							
			Transparency when not in use							
	Shortcut from lock screen									
	Text-to-speech output							Preferred engine		
								Language		
				Speech rate						
				Pitch						
Play/Reset										

Menu	Sub-menu	Menu Option		
Security & Privacy	Device may be at risk			
	Add Google Account			
	Check for security updates			
	Check for system updates			
	App security	Google Play protect		
	Device unlock	Screen lock PIN	Enhanced PIN privacy	
			Lock after screen timeout	Immediately
				5 seconds
				15 seconds
				30 seconds
				1 minute
				2 minute
				5 minute
				10 minute
	30 minute			
Never				
Account security	Google security Checkup			
	Password checkup			
Device finders	Find my device	Use find my device		
	Unknow tracker alerts			

Menu	Sub-menu	Menu Option		
Security & Privacy	System & updates	Check for security updates		
		Check for system updates		
		Security update		
		Google Play system update		
		Backup		
	Privacy	Permission manager		
		Privacy dashboard		
		Ads	Ad privacy	Ad topics
				App-suggested ads
				Ad measurement
		Reset advertising ID		
		Delete advertising ID		
		Enable debug logging for ads		
		Health connect		
		Data sharing updates for location		
		Camera access		
		Microphone access		
Show clipboard access				
Show passwords				

Menu	Sub-menu	Menu Option			
Security & Privacy	Privacy	Location access	Use location		
			No apps recently accessed location		
			App location permissions		
			Location services		
		Activity controls			
	More security settings	Accessibility usage			
		Notifications on lock screen	Show all notification content		
			Show sensitive content only when unlocked		
			Don't show notifications at all		
		Show media on lock screen			
		App content			
		Android system Intelligence	Device learning		
			Keyboard		
			On-device recognition		
			Clear data		Last hour
		Last 24 hours			
		All time			

Menu	Sub-menu	Menu Option			
Security & Privacy	More security settings	Encryption & credentials	Encrypt device		
			Trusted credentials		
			User credentials		
			Install a certificate		CA certificate
					VPN & app user certificate
					Wi-Fi certificate
			Clear credentials		
			Certificate management app		
			Trust agents		Extend unlock
			App pinning		Use app pinning
Lock device when unpinning					
Location	Use location				
	Recent access				
	App location permissions			App list	
	Location services			Earthquake alerts	
				Emergency location Service	
				Google location History	
				Google location Sharing	
				Location accuracy	
				Trusted places	
				Wi-Fi scanning	
				Bluetooth scanning	

Menu	Sub-menu	Menu Option			
Passwords & accounts	Passwords				
	Autofill service				
	Accounts for owner				
	Add account				
	Automatically sync app data				
Digital Wellbeing	Your Digital Wellbeing tools	Unlocks			
		Notifications			
	View activity details				
	App limits				
	Night shift	Do not disturb for night shift mode			
	Focus				
	Screen time reminders				
	Manage notifications	App notifications			
	Do Not Disturb	People	Messages	Starred contacts	
				Contacts	
				Priority conversations	
				Anyone	
				None	
Calls		Starred contacts			
		Contacts			
		Anyone			
		None			
Apps		Apps			
	Add apps				

Menu	Sub-menu	Menu Option			
Digital Wellbeing	Do not disturb	Alarms & other interruptions	Alarms		
			Media sound		
			Touch sounds		
			Reminders		
			Calendar events		
		Schedule	Sleeping	User schedule	
				Days	
				Start time	
				End time	
				Alarm can override end time	
				Do not disturb behavior	
			Event	User schedule	
				During events for	
				Where reply is	
				Do not disturb behavior	
		Duration for quick settings	Add more		
			Until you turn off		
			For 1 hour		
				Ask every time	

Menu	Sub-menu	Menu Option		
Digital Wellbeing	Do not disturb	Display options for hidden notifications	No sound from notifications	
			No visuals or sound from notifications	
			Custom	Don't turn on screen
				Don't wake for notifications
				Hide notification dots on app icons
				Hide status bar icons at top of screen
				Don't pop notifications on screen
				Hide from pull-down shade
			Heads up	
			Show icon in the app list	
Parental controls				

Menu	Sub-menu	Menu Option			
Google	Google services				
	Backup is off for photos & videos	Account storage			
		Backup by Google One			
		Backup details			
		Apps			
		Photo & videos			
		Device settings			
		Google account data	Calendar		
			Contacts		
			Drive		
			Gmail		
			Google Calendar		
			Google TV		
		Tasks in Calendar			
		Back up using meter Wi-Fi data			
	Find my device	Use find my devices			
		Find your offline devices	Off		
			Without network		
			With network in high-traffic areas only		
			With network in all areas		
		Find my device app			
	Find my device web				

Menu	Sub-menu	Menu Option		
Google	Autofill	Use autofill with Google		
		Google Account		
		Personal info		
		Google Password Manager		
		Google Pay		
		Preferences		
	Google Wallet			
	Cross-device services	Account		
		Device name		
		Who can share with you	Your devices	
			Contacts	
	Everyone			
	Family group	Creat a family group		
	What's new			
	Give feedback			
	Parental Controls			

Menu	Sub-menu	Menu Option	
Advanced	Startup & shutdown	Boot mode	Normal mode
			Secure mode
			Disable embeded OS
		Startup input	Last shutdown channel
			ViewBoard
			HDMI 1
			HDMI 2
			HDMI 3
			HDMI 4
			DP
			VGA
			TYPE C 1
			TYPE C 2
		Standby Mode	Hibernate
			Sleep
		Energy Star mode	
		Add startup/ shutdown task	Startup task/ Shutdown task
			Schedule settings

Menu	Sub-menu	Menu Option	
Advanced	Input source	Label input Source	Allow input alias
			ViewBoard
			HDMI 1
			HDMI 2
			HDMI 3
			HDMI 4
			DP
			VGA
			Type-C 1
			Type-C 2
		Wake up by active HDMI input	
		Auto search signal	
		Auto switch input ports	
			Manual selection
		Energy saving	1 min
			3 mins
			5 mins
			10 mins
			15 mins
			30 mins
			45 mins
			60 mins
			Off
HDMI CEC			
HDR			

Menu	Sub-menu	Menu Option			
Advanced	Security settings	Unknown source security			
		Enable password for ViewBoard settings			
		Reset Advanced Settings Password			
	Pen detection				
	Pen detection app	Marker			
		myViewBoard whiteboard			
	HDMI OUT format	3840 x 2160 @ 60 Hz			
		1920 x 1080 @ 60 Hz			
		720 x 480 @ 60 Hz			
		Auto			
System	System languages				
	App Languages				
	Regional preferences	Regional preferences			
		Temperature	Use default		
			Celsius (°C)		
			Fahrenheit (°F)		
		First day of week	Use default		
			Sunday		
			Monday		
			Tuesday		
			Wednesday		
			Thursday		
	Friday				
	Saturday				
	Voice input				

Menu	Sub-menu	Menu Option			
System	On-device recognition	Add language			
		Auto update languages			
		Advanced			
	Text-to-speech output	Preferred engine			
		Languages			
		Speech rate			
		Pitch			
		Play/Reset			
	Launcher Scheme	Scheme A			
		Scheme B			
	Sidebar	On/Off			
	Keyboard	Gboard			
		Google Voice Typing			
		Remoting			
		Use on-screen keyboard			
		Keyboard shortcuts	Caps lock		
			Ctrl		
			Action key		
			Alt		
			Reset all		
		Spell checker	Use spell checker		
			Languages		
			Default spell checker		
		Personal dictionary			
		Pointer speed			

Menu	Sub-menu	Menu Option	
System	Gestures	Navigation mode	Gesture navigation
			3-button navigation
			Side toolbar navigation
		Press & hold power button	Power menu
			Digital assistant
	Date & time	Set time automatically	Date
			Time
			Set automatically
			Time zone
		Time zone	Region
			Time zone
		Use locale default	
	Use 24-hour format		
	Windows Ink		
	Display ID		
	Backup		
	System Update		
	Multiple Users	Allow multiple users	
		User	
		Add user	
		Add guest	
		Delete guest activity	
		Add users from lock screen	

Menu	Sub-menu	Menu Option	
System	Reset options	Reset Wi-Fi & Bluetooth	
		Reset app preferences	
		Erase all data (factory rest)	
About Device	Device name		
	Legal information	Third-party license	
		Google legal	
		Google Play system update license	
		System Webview license	
		Wallpaper credits	
		Open source licenses	
	Model	Model	
		Serial number	
		Asset Tagging	
	Android version	Android version	
		Android security update	
		Kernel version	
		Build number	

Menu	Sub-menu	Menu Option
About Device	IP address	
	Ethernet address	
	Wi-Fi MAC address	
	Device Wi-Fi MAC address	
	Bluetooth address	
	Up time	
	Build number	
Tips & Support	myViewBoard Whiteboard	
	myViewBoard Display	
	myViewBoard Manager	
	New features	

Pre-installed Applications and Settings

AirSync

Wirelessly mirror screens to a larger display.

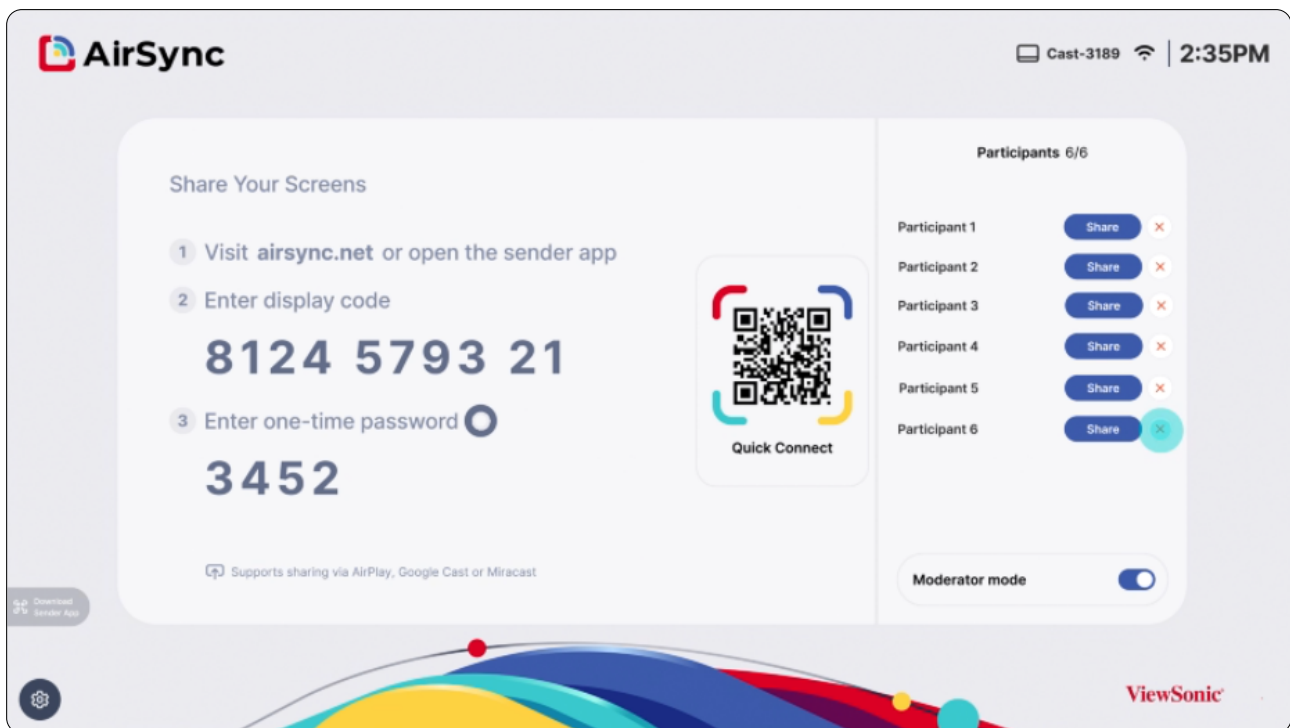

To share a screen to a ViewBoard with AirSync:

1. Open AirSync on the ViewBoard you want to share your screen to.
2. On the device you want to share the screen from, go to: <https://airsync.net>.
3. Enter the **Display Code** and **One Time Password** for the ViewBoard you wish to share to.

NOTE: The password refreshes every 30 seconds.

myViewBoard Manager

Remotely manage multiple installations of ViewSonic devices.

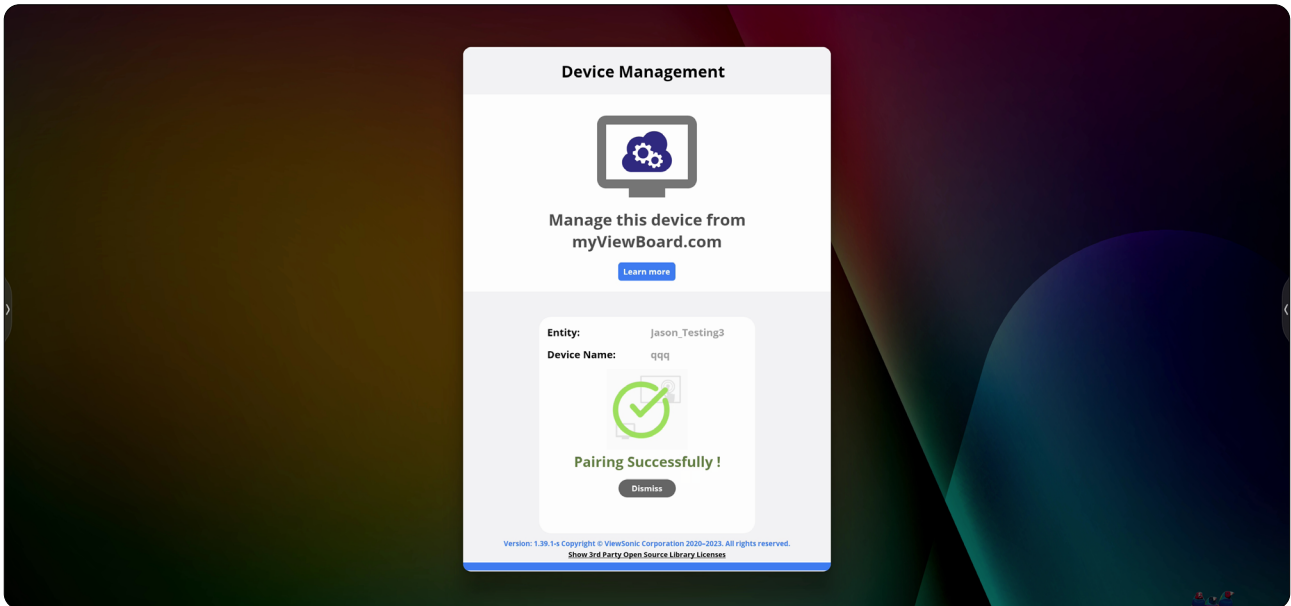

Once devices are set up and have myViewBoard Manager installed, they can be added to the entity and managed remotely from the Manager web application.

NOTE: Only available to Entity Admins from myviewboard.com after signing in.

Add a Device

On the device to manage:

1. Download and install myViewBoard Manager.
2. Open myViewBoard Manager and note the 6-digit PIN displayed.

In the myViewBoard Manager web application on myviewboard.com:

1. Click **Add Device**.
2. Input the 6-digit PIN obtained earlier.
3. Name the device (if applicable).
4. Click **Add**.

NOTE: To learn more about myViewBoard Manager, visit: https://myviewboard.com/kb/en_US/getting-started/overview-manager.

myViewBoard Whiteboard

A digital whiteboarding application.



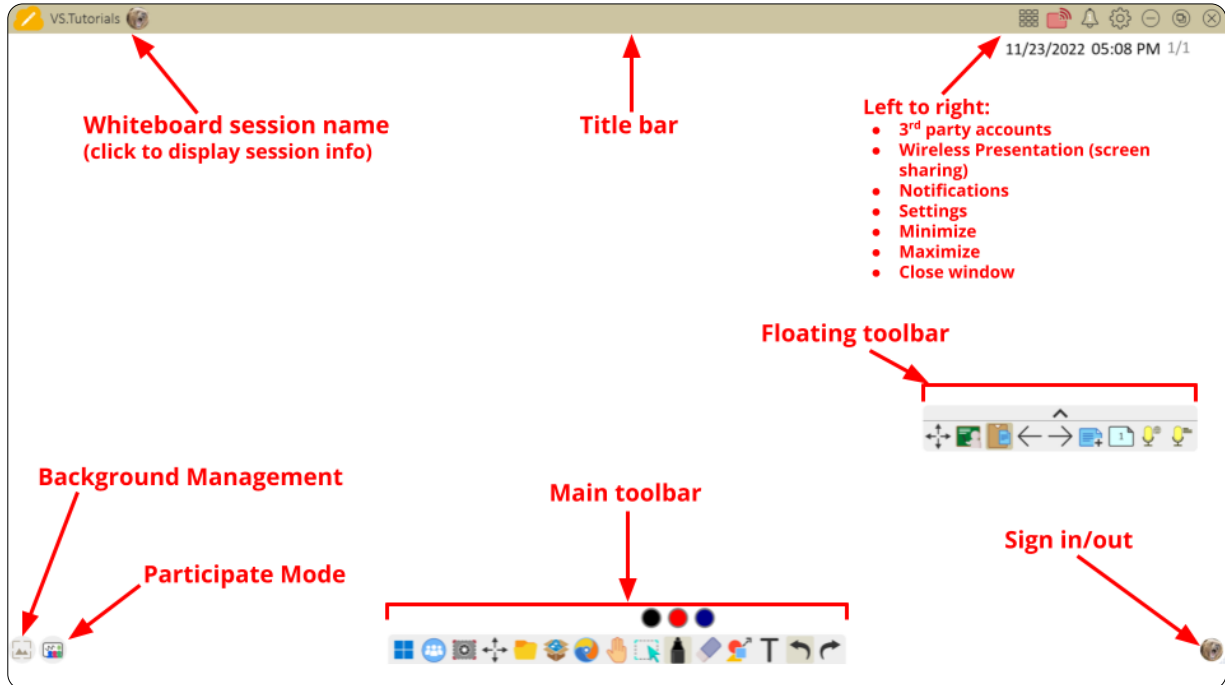









NOTE: To learn more about myViewBoard Whiteboard, visit: https://myviewboard.com/kb/en_US/getting-started-whiteboard/overview-whiteboard.









Floating Toolbar

Item	Description
	Move Move the Floating Toolbar.
	Present Mode Switch between presentation and preparation modes.
	Paste from Clipboard Insert the current clipboard content onto the canvas.
	Previous Page Go to the previous page (if the canvas has multiple pages).
	Next Page Go to the next page (if the canvas has multiple pages).
	New Page Add a new canvas.
	Pages in Whiteboard Create, select, rearrange, copy and delete pages.

Main Toolbar

	Item	Description
	Screen Capture	Screenshot, video, and audio recording.
	Move	Select and hold to move the toolbar to the left side, right side, or bottom of the screen.
	File	Open, save, export, and print whiteboard files.
	Magic Box	Import resources (image, video, audio, etc.) to the whiteboard.
	Embedded Browser	Open the built-in browser to access internet resources, which can be dragged onto the canvas.
	Infinite Canvas	Drag to move the canvas. Use two hands to zoom in/zoom out. Select again for an overview.
	Selection	Select objects, text, and other elements on the canvas.
	Pen	Writing tools and customization options.
	Eraser	Erase objects or clear the page.
	Shapes and Lines	Draw shapes, arrows, and add tables.
	Text and Handwriting	Add a text box.
	Undo	Undo the previous action.
	Redo	Redo the previous action.

Background Management

Item		Description
	Sign In	Sign in to a myViewBoard account.
	Background Management	Change the canvas background.
	FollowMe Setting	Display custom images uploaded to a cloud storage account.
	Color Palette	Choose from solid or gradient colors as the background.
	Pre-installed	Choose backgrounds that come pre-installed with Whiteboard.
	myViewBoard Originals	Display original content created by myViewBoard.
	Local Hard Drive	Use images from the local hard drive.

RS-232 Protocol

This document describes the hardware interface and software protocols of RS-232 interface communication between the ViewSonic LED Display and computers or other control units with RS-232 protocol.

The protocol contains three command sections:

- Set-Function
- Get-Function
- Remote control pass-through mode

NOTE: Below, “PC” represents all the control units that can send or receive the RS-232 protocol command.

Description

RS-232 Hardware Specification

ViewSonic LFD communication port on the rear side:

1. Connector type: DSUB 9-Pin Male (female or 3.5 mm barrel connector)
2. Use of crossover (null modem) cable for connection
3. Pin Assignment:

Male DSUB 9-Pin
(preferred)

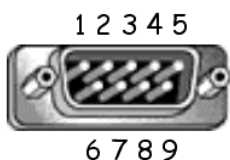

Female DSUB 9-Pin

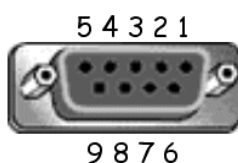

3.5 mm barrel connector
(alternative for limited
space)



Pin #	Signal	Remark
1	NC	
2	RXD	Input to Display
3	TXD	Output from Display
4	NC	
5	GND	
6	NC	
7	NC	
8	NC	
9	NC	
frame	GND	

Item	Signal	Remark
Tip	TXD	Output from Display
Ring	RXD	Input to Display
Sleeve	GND	

LAN Hardware Specification

ViewSonic LFD communication port on the rear side:

1. Connector type: 8P8C RJ45
2. Pin Assignment:

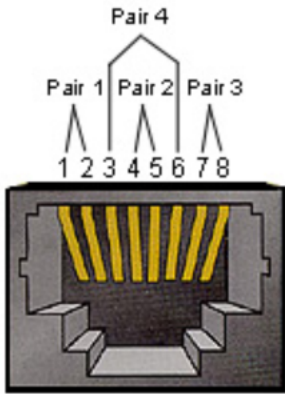

Pin #	Signal	Remark
1	TX+	Output from Display
2	TX-	Output from Display
3	RX+	Input to Display
4	BI_D3+	For 1G case
5	BI_D3-	For 1G case
6	RX-	Input to Display
7	BI_D4+	For 1G case
8	BI_D4-	For 1G case
frame	GND	

RS-232 Communication Setting

- Baud Rate Select: 9600bps (fixed)
- Data bits: 8 bits (fixed)
- Parity: None (fixed)
- Stop Bits: 1 (fixed)

LAN Communication Setting

Type: Ethernet
 Protocol: TCP/IP
 Port: 5000 (fixed)
 WOL Port: 9 (fixed) for UDP*3.2.0
 Cross subnet: No
 Logon Credentials: No

Command Message Reference

PC sends to LFD command packet followed by “CR”. Every time PC sends control command to Display, the Display shall respond as follows:

1. If the message is received correctly it will send “+” (02Bh) followed by “CR” (00Dh)
2. If the message is received incorrectly it will send “-” (02Dh) followed by “CR” (00Dh)

Protocol

Set-Function Listing

The PC can control the Display for specific actions. The Set-Function command allows you to control the Display behavior at a remote site through the RS-232 port. The Set-Function packet format consists of 9 bytes.

Set-Function Description:

- Length:** Total Byte of Message excluding "CR"
- LFD ID** Identification for each Display (01~98; default is 01)
ID "99" means to apply the set command for all connected displays. Under such circumstances, only ID#1 display has to reply.
The LFD ID can be set via the OSD menu for each Display.
- Command Type** Identify command type,
"s" (0x73h): Set Command
"+" (0x2Bh): Valid command Reply
"- " (0x2Dh): Invalid command Reply
- Command:** Function command code: One byte ASCII code.
- Value[1~3]:** Three bytes ASCII that defines the value.
- CR** 0x0D

Set-Function Format

Send: (Command Type="s")

Name	Length	ID	Command Type	Command	Value1	Value2	Value3	CR
Byte Count	1 Byte	2 Byte	1 Byte	1 Byte	1 Byte	1 Byte	1 Byte	1 Byte
Bytes order	1	2~3	4	5	6	7	8	9

Reply: (Command Type="+" or "-")

Name	Length	ID	Command Type	CR
Byte Count	1 Byte	2 Byte	1 Byte	1 Byte
Bytes order	1	2~3	4	5

NOTE: When PC applies command to all displays (ID=99), only the #1 set needs to reply by the name of ID=1.

Example 1: Set Brightness at 76 for Display (#02) and this command is valid

Send (Hex Format)

Name	Length	ID	Command Type	Command	Value1	Value2	Value3	CR
Hex	0x38	0x30 0x32	0x73	0x24	0x30	0x37	0x36	0x0D

Reply (Hex Format)

Name	Length	ID	Command Type	CR
Hex	0x34	0x30 0x32	0x2B	0x0D

Example 2: Set Brightness at 75 for Display (#02) and this command is NOT valid

Send (Hex Format)

Name	Length	ID	Command Type	Command	Value1	Value2	Value3	CR
Hex	0x38	0x30 0x32	0x73	0x24	0x30	0x37	0x35	0x0D

Reply (Hex Format)

Name	Length	ID	Command Type	CR
Hex	0x34	0x30 0x32	0x2D	0x0D

Set-Function Table

A. Basic Function

Set Function	Length	ID	Command		Value Range	Comments
			Type (ASCII)	Code (ASCII) Code (Hex)		
Power ON *3.2.1/ OFF (standby)	8		s	!	21 000: STBY 001: ON	1. The Power-on via LAN control may work only under specific modes. See display UG for details. *3.1.1 2. "WOL by MAC address" maybe available as an alternative.*3.2.1
Input Select	8		s	"	22 000: TV 001: AV 002: S-Video 003: YPbPr 004: HDMI1 014: HDMI2 024: HDMI3 034: HDMI4 005: DVI 006: VGA1 016: VGA2 026: VGA3 007: Slot-in PC (OPS/SDM)/HDBT 008: Internal memory 009: DP1 *3.2.4 023: DP2 019: Type-C 1 *3.3.2 039: Type-C 2 00A: Embedded/Main (Android)	1. No need for USB 2. For the case of two or more same sources, the 2nd digital is used to indicate the extension. 3. The HEX of 00A is 30 30 41. 4. 00Z is reserved for cycle mode *3.3.1 5. Using 2nd digi to identify DP or Type C. 0 and even numbers stand for DP; odd numbers stand for Type C *3.3.2
Brightness	8		s	\$	24 000 ~ 100 900: Bright down (-1) 901: Bright up (+1) *3.1.1	
Backlight *3.2.0	8		A	B	42 000 ~ 100	1. For Android platform whose main mode is controlled by backlight and the other sources are controlled by brightness. 2. Derived from Color calibration. *3.2.0
Power lock	8		s	4	34 000: Unlock 001: Lock	*See note in details
Volume	8		s	5	35 000 ~ 100 900: Volume down(-1) 901:Volume up(+1)	
Mute	8		s	6	36 000: OFF 001: ON (mute)	
Button lock	8		s	8	38 000: Unlock 001: Lock	*See note in details
Menu lock	8		s	>	3E 000: Unlock 001: Lock	*See note in details

Set Function	Length	ID	Command	Command	Value Range	Comments	
Number *3.1.1	8		s	@	40	000~009	
Key Pad *3.1.1	8		s	A	41	000: UP 001: DOWN 002: LEFT 003: RIGHT 004: ENTER 005: INPUT 006: MENU/(EXIT) 007: EXIT	
Remote Control	8		s	B	42	000: Disable 001: Enable 002: Pass through	Disable: RCU will have no function Enabled: RCU controls normally Pass through: Display will bypass the RC code to connected device via the RS-232 port, but not react itself.
Restore default	8		s	~	7E	000	Recover to factory settings

NOTE:

1. Behavior at Lock Modes

Lock Mode	Behavior
Button Lock	<ol style="list-style-type: none">1. Lock all buttons on the front panel and RCU, except for “Power”2. All the SET functions should be workable via RS-232, even the ones with according hot key in RCU like Mute,...etc.
MENU Lock	<ol style="list-style-type: none">1. Lock the “MENU’ key of front panel and RCU2. The Factory and Hospitality modes should not be blocked for the model using MENU-combined key to enter these two modes. Alternative approach will be indicated separately if any limitation by model.
POWER Lock	<ol style="list-style-type: none">1. Lock the “POWER” key on the front and RCU.2. The SET_POWER ON/OFF should be workable via RS-232, but does not mean the POWER lock will be released under this case.3. Can not be unlocked by reset in OSD setting4. Will auto AC power-on in power-lock5. Under power-lock, the set will not enter power saving when no PC signal and neither turn off when no other video signals after 15 minutes.
Remote Control Disable	Lock the RCU keys, but keep the front panel buttons workable.

2. Wake-on-LAN by MAC address as alternative for SET Power on

(Length=126 Bytes)

6 Bytes	6 Bytes (#1)	6 Bytes (#2)	...	6 Bytes (#16)	24 Bytes
0xFF FF ... FF	MAC address	MAC address	...	MAC address	0x00 00 ... 00

B. Optional Function

Set Function	Length	ID	Command	Command		Value Range (Three ASCII bytes)	Comments
				Type (ASCII)	Code (ASCII)		
Contrast	8		s	#	23	000 ~ 100	
Sharpness	8		s	%	25	000 ~ 100	
Color	8		s	&	26	000 ~ 100	
Tint	8		s	'	27	000 ~ 100	
Backlight On_Off	8		s	(29	000: OFF 001: ON	
Color mode	8		s)	29	000: Normal 001: Warm 002: Cold 003: Personal	
Surround sound	8		s	-	2D	000: OFF 001: ON	
Bass	8		s	.	2E	000 ~ 100	
Treble	8		s	/	2F	000 ~ 100	
Balance	8		s	0	30	000 ~ 100	050 is central
Picture Size	8		s	1	31	000: FULL (16:9) 001: NORMAL (4:3) 002: REAL (1:1) *3.1.0	
OSD language	8		s	2	32	000: English 001: French 002: Spanish	Could be extended for more supported languages by model
PIP-Mode	8		s	9	39	000: OFF 001: PIP(POP) 002: PBP	
PIP-Sound select	8		s	:	3A	000: Main 001: Sub	
PIP-Position	8		s	;	3B	000: Up 001: Down 002: Left 003: Right	
PIP-Input	8		s	7	37 *2.9	000: TV 001: AV 002: S-Video 003: YPbPr 004: HDMI1 014: HDMI2 024: HDMI3 034: HDMI4 005: DVI 006: VGA1 016: VGA2 026: VGA3 007: Slot-in PC (OPS/SDM)/HDBT 008: Internal memory 009: DP/Type-C *3.2.4 00A: Embedded/Main (Android)	Value range is same as SET-Input select

Set Function	Length	ID	Command	Command	Value Range	Comments
Tiling-Mode	8		s	P	50	000: OFF 001: ON (for video wall)
Tiling-Compensation	8		s	Q	51	000: OFF 001: ON (for video wall) Bezel width compensation
Tiling-H by V Monitors	8		s	R	52	01x~09x: H 0x1~0x9: V (for video wall) 1. 2nd digital for H monitors 2. 3rd digital for V monitors
Tiling-Position	8		s	S	53	001~025 (for Video wall) Copy the screen of Position# to identified display
Date: Year	8		s	V	56	Y17~Y99 Last 2 digits (20)17~(20)99
Date: Month	8		s	V	56	M01~M12 2 digits
Date: Day	8		s	V	56	D01~D31 2 digits
Time: Hour	8		s	W	57	H00~H23 24-hr format. 2 digits.
Time: Min	8		s	W	57	M00~M59 2 digits
Time: Sec	8		s	W	57	S00~S59 2 digits

NOTE:

3. Tiling definition of H Monitors, V Monitors, and Position

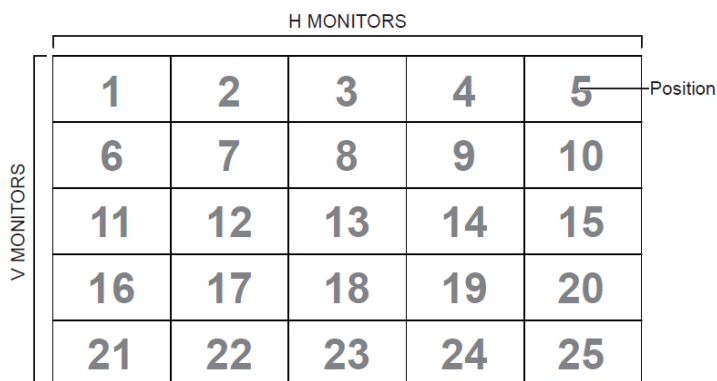

4. Set Date example

Date: 2017-3/15

Send: 0x 38 30 31 73 56 59 31 37 0D ("Y17")

Send: 0x 38 30 31 73 56 4D 30 33 0D ("M03")

Send: 0x 38 30 31 73 56 44 31 35 0D ("D15")

5. Set Time example

Time: 16:27:59

Send: 0x 38 30 31 73 57 48 31 36 0D ("H16")

Send: 0x 38 30 31 73 57 4D 32 37 0D ("M27")

Send: 0x 38 30 31 73 57 53 35 39 0D ("S59")

Get-Function Listing

The PC can interrogate the LFD for specific information. The Get-Function packet format consists of 9 bytes which is similar to the Set-Function packet structure. Note that the “Value” byte is always = 000.

Get-Function Description:

- Length:** Total Byte of Message excluding “CR”.
- TV/DS ID** Identification for each of TV/DS (01~98; default is 01).
- Command Type** Identify command type,
 “g” (0x67h) : Get Command
 “r” (0x72h) : Valid command Reply
 “-” (0x2Dh) : Invalid command Reply
- Command:** Function command code: One byte ASCII code.
- Value[1~3]:** Three bytes ASCII that defines the value.
- CR** 0x0D

Get-Function Format

Send: (Command Type=“g”)

Name	Length	ID	Command Type	Command	Value1	Value2	Value3	CR
Byte Count	1 Byte	2 Byte	1 Byte	1 Byte	1 Byte	1 Byte	1 Byte	1 Byte
Bytes order	1	2~3	4	5	6	7	8	9

Reply: (Command Type=“r” or “-”)

If the Command is valid, Command Type = “r”

Name	Length	ID	Command Type	Command	Value1	Value2	Value3	CR
Byte Count	1 Byte	2 Byte	1 Byte	1 Byte	1 Byte	1 Byte	1 Byte	1 Byte
Bytes order	1	2~3	4	5	6	7	8	9

If the Command is NOT valid, Command Type = “-”

Name	Length	ID	Command Type	CR
Byte Count	1 Byte	2 Byte	1 Byte	1 Byte
Bytes order	1	2~3	4	5

Example 1: Get Brightness from TV-05 and this command is valid. The Brightness value is 67.

Send (Hex Format)

Name	Length	ID	Command Type	Command	Value1	Value2	Value3	CR
Hex	0x38	0x30 0x35	0x67	0x62	0x30	0x30	0x30	0x0D

Reply (Hex Format)

Name	Length	ID	Command Type	Command	Value1	Value2	Value3	CR
Hex	0x38	0x30 0x35	0x72	0x62	0x30	0x36	0x37	0x0D

Example 2: Get Color from Display (#05), but the Color command is not supported by this model.

Send (Hex Format)

Name	Length	ID	Command Type	Command	Value1	Value2	Value3	CR
Hex	0x38	0x30 0x35	0x67	0x26	0x30	0x30	0x30	0x0D

Reply (Hex Format)

Name	Length	ID	Command Type	CR
Hex	0x34	0x30 0x35	0x2D	0x0D

Get-Function Table

A. Basic Function

Get Function	Length	ID	Command		Response Range (Three ASCII bytes)	Comments
			Type (ASCII)	Code (ASCII) Code (Hex)		
Get-Brightness	8		g	b 62	000 ~ 100	
Get-Backlight *3.2.0	8		a	B 42	000 ~ 100	1. For Android platform whose main mode is controlled by backlight and the other sources are controlled by brightness. 2. Derived from Color calibration. *3.2.0
Get-Volume	8		g	f 66	000 ~ 100	
Get-Mute	8		g	g 67	000: OFF 001: ON (muted)	
Get-Input select	8		g	j 6A	000~ 100~	1. 1st digit for signal detection: 0 means "no signal"; 1 means "signal detected" 2. 2nd & 3rd digit: See Set-function table
Get-Power status: ON/ STBY	8		g	l 6C	001: ON 000: STBY	
Get-Remote control	S		g	n 6E	000: Disable 001: Enable 002: Pass through	Get RCU mode status
Get-Power lock	8		g	o 6F	000: Unlock 001: Lock	
Get-Button lock	8		g	p 70	000: Unlock 001: Lock	
Get-Menu lock	8		g	l 6C	000: Unlock 001: Lock	
Get-ACK	8		g	z 7A	000	This command is used to test the communication link
Get-Thermal	8		g	0 30	000~100: 0~+100 deg C -01~-99: -1~-99 deg C	
Get-Operation hour *3.2.0	8		g	1 31	000	1. Accumulated hours in 6-digit integer (000,001~ 999,999) *3.2.0 2. Can not be reset when FW update and Factory initiation *3.2.2 3. Reply in new 32-byte format *3.2.0
Get-Device name	8		g	4 34	000	Reply in new 32-byte format *3.2.0

Get Function	Length	ID	Command	Command		Response Range	Comments
Get-MAC address	8		g	5	35	000	(for the models with LAN) Reply in new 32-byte format *3.2.0
Get-IP address *3.2.0	8		g	6	36	000	(for the models with LAN) Reply in new 32-byte format *3.2.0
Get-Serial number *3.2.0	8		g	7	37	000	Reply in new 32-byte format *3.2.0
Get-FW version *3.2.0	8		g	8	38	000	Reply in new 32-byte format *3.2.0

NOTE:

1. Get Operation Hour example

Assumed the accumulated operation hour is 123,456 hrs

Send: 0x 38 30 31 67 31 30 30 30 0D (Get Operation hour)

Reply: 0x 32 30 31 72 31 31 32 33 34 35 36 00 00 ... 00 00 0D

2. Get Device Name example

Assumed the device name is CDE-5500

Send: 0x 38 30 31 67 34 30 30 30 0D (Get Device Name)

Reply: 0x 32 30 31 72 34 43 44 45 2D 35 35 30 30 00 00 ... 00 00 0D

Assumed the device name is "NMP-302#1"

Send: 0x 38 30 31 67 34 30 30 30 0D (Get Device Name)

Reply: 0x 32 30 31 72 34 4E 4D 50 2D 33 30 32 23 31 00 00 ...00 00 0D

3. Get MAC address example

Assumed the MAC address is 00:11:22:aa:bb:cc

Send: 0x 38 30 31 67 35 30 30 30 0D (Get MAC add)

Reply: 0x 32 30 31 72 35 30 30 31 31 32 32 61 61 62 62 63 63 00 00...00 00 0D

4. Get IP address example

Assumed the IP address is 192.168.100.2

Send: 0x 38 30 31 67 36 30 30 30 0D (Get IP address)

Reply: 0x 32 30 31 72 36 31 39 32 2E 31 36 38 2E 31 30 30 2E 32 00 00...00 00 0D

5. Get Serial number example

Assumed the Serial number is ABC180212345

Send: 0x 38 30 31 67 37 30 30 30 0D (Get Serial number)

Reply: 0x 32 30 31 72 37 41 42 43 31 38 30 32 31 32 33 34 35 00 00...00 00 0D

6. Get FW version example

Assumed the FW version is 3.02.001

Send: 0x 38 30 31 67 38 30 30 30 0D (Get FW version)

Reply: 0x 32 30 31 72 38 33 2E 30 32 2E 30 30 31 00 00...00 00 0D

B. Optional Function

Get Function	Length	ID	Command		Response Range (Three ASCII bytes)	Comments
			Type (ASCII)	Code (ASCII) Code (Hex)		
Get-Contrast	8		g	a 61	000 ~ 100	
Get-Sharpness	8		g	c 63	000 ~ 100	
Get-Color	8		g	d 64	000 ~ 100	
Get-Tint	8		g	e 65	000 ~ 100	
Get-Backlight On_Off	8		g	h 68	000: OFF 001: ON	
Get-PIP mode	8		g	t 74	000: OFF 001: PIP (POP) 002: PBP	
Get-PIP input	8		g	u 75	000 ~	See Set-input select
Get-Tiling Mode	8		g	v 76	000: OFF 001: ON	(for Video wall)
Get-Tiling Compensation	8		g	w 77	000: OFF 001: ON	(for Video wall) Bezel width compensation
Get-Tiling H by V monitors	8		g	x 78	01x~09x: H monitors 0x1~0x9: V monitors	(for Video wall) 1. 2nd digital for H monitors 2. 3rd digital for V monitors
Get-Tiling position	8		g	y 79	000: OFF 001~025	(for Video wall) Copy the screen of Position# to identified display
Get-Date: Year	8		g	2 32	Y00~Y00	Last 2 digits (20)17~(20)99
Get-Date: Month	8		g	2 32	M00~M00	2 digits
Get-Date: Day	8		g	2 32	D00~M00	2 digits
Get-Time: Hour	8		g	3 33	H00~H00	24-hr format. 2 digits
Get-Time: Min	8		g	3 33	M00~M00	2 digits
Get-Time: Sec	8		g	3 33	S00~S00	2 digits

NOTE:

1. Get Date example

Assumed the current date of display#01 as below:

Date: 2017-3/15

Send: 0x 38 30 31 67 32 59 30 30 0D (Get Date:Year)

Reply: 0x 38 30 31 72 32 59 31 37 0D ("Y17")

Send: 0x 38 30 31 67 32 4D 30 30 0D (Get Date:Month)

Reply: 0x 38 30 31 72 32 4D 30 33 0D ("M03")

Send: 0x 38 30 31 67 32 44 30 30 0D (Get Date:Day)

Reply: 0x 38 30 31 72 32 44 31 35 0D ("D15")

2. Get Time example

Assumed the current time of display#01 as below:

Time: 16:27:59

Send: 0x 38 30 31 67 33 48 30 30 0D (Get Time:Hour)

Reply: 0x 38 30 31 72 33 48 31 36 0D ("H16")

Send: 0x 38 30 31 67 33 4D 30 30 0D (Get Time:Min)

Reply: 0x 38 30 31 72 33 4D 32 37 0D ("M27")

Send: 0x 38 30 31 67 33 53 30 30 0D (Get Time:Sec)

Reply: 0x 38 30 31 72 33 53 35 39 0D ("S59")

3. Get RS232 version example

Assumed the version is 3.0.1

Send: 0x 38 30 31 67 36 30 30 30 0D (Get RS232 version)

Reply: 0x 38 30 31 72 36 33 30 31 0D ("301")

C. Auto Reply *3.2.1

The display will send out the updated data/status automatically without GET query from the host whenever the following data/status is changed by the user through any of the available ways like: remote control unit, front control panel keys, or touch screen.

- Power On/Off
- Input Select
- Brightness
- Backlight
- Volume
- Mute On/Off

Remote Control Pass-through Mode

When the PC sets the Display to Remote Control Pass through mode, the Display will send a 7-byte packet (followed by “CR”) in response to remote control unit (RCU) button activation.

In this mode the RCU will have no effect on the Display function. For example: “Volume+” will not change the volume of the Display, but instead only send the “Volume+” code to the PC over the RS-232 port.

IR Pass Through-Function format

Reply: (Command Type=“p”)

Name	Length	ID	Command Type	RCU Code1 (MSB)	RCU Code2 (LSB)	CR
Byte Count	1 Byte	2 Byte	1 Byte	1 Byte	1 Byte	1 Byte
Bytes order	1	2~3	4	5	6	7

Example 1: Remote Control Pass-through when “VOL+” key is pressed for Display (#5)

Send (Hex Format)

Name	Length	ID	Command Type	RCU Code1 (MSB)	RCU Code2 (LSB)	CR
Hex	0x36	0x30 0x35	0x70	0x31	0x30	0x0D

Key	Code (HEX)	Basic *3.1.1	Optional *3.1.1
1	01	V	
2	02	V	
3	03	V	
4	04	V	
5	05	V	
6	06	V	
7	07	V	
8	08	V	
9	09	V	
0	0A	V	
-	0B		V
RECALL (LAST)	0C		V
INFO (DISPLAY)	0D		V
	0E		
ASPECT (ZOOM, SIZE)	0F		V
VOLUME UP (+)	10	V	
VOLUME DOWN (-)	11	V	
MUTE	12	V	
CHANNEL/PAGE UP (+)/ BRIGHTNESS+	13		V
CHANNEL/PAGE DOWN (-)/ BRIGHTNESS-	14		V
POWER	15	V	
SOURCES (INPUTS)	16	V	
	17		
	18		
SLEEP	19		V
MENU	1A	V	
UP	1B	V	
DOWN	1C	V	
LEFT (-)	1D	V	
RIGHT (+)	1E	V	
OK (ENTER, SET)	1F	V	
EXIT	20	V	
	21		
	22		
	23		
	24		
	25		
	26		
	27		
	28		
	29		

Key	Code (HEX)	Basic *3.1.1	Optional *3.1.1
	2A		
	2B		
RED ■ (F1)	2C		V
GREEN ■ (F2)	2D		V
YELLOW ■ (F3)	2E		V
BLUE ■ (F4)	2F		V

NOTE:

1. This IR-pass-through code is different from the RCU key code.
2. Special control sequence for POWER key under IR-pass through mode.
 - 2-1. When Display is OFF and receives the IR POWER code: Display will turn itself ON, then forward the POWER code to the host via RS-232.
 - 2-2. When Display is ON and receives the IR POWER code: Display will forward the POWER code to the host via RS-232, then turn OFF itself.
 - 2-3. When SET-POWER LOCK is enabled, the Display will not respond to POWER key pressing.
3. The VOLUME UP and VOLUME DOWN code will repeatedly output when you press and hold the keys.

Appendix

Display Modes

DisplayPort

Resolution	Refresh Rate (@)
640 x 480	60, 67, 72 Hz
800 x 600	56, 60, 72, 75 Hz
832 x 624	75 Hz
1024 x 768	60, 70, 75 Hz
1152 x 864	75 Hz
1152 x 870	75 Hz
1280 x 720	60 Hz
1280 x 960	60 Hz
1280 x 1024	60, 75 Hz
1360 x 768	60, 85 Hz
1366 x 768	60 Hz
1440 x 900	60 Hz
1600 x 1200	60 Hz
1680 x 1050	60 Hz
1920 x 1080	60 Hz
1920 x 1200	60 Hz
3840 x 2160	25, 30, 50, 60 Hz

HDMI

Resolution	Refresh Rate (@)
640 x 480	60, 67, 72, 75 Hz
800 x 600	56, 60, 72, 75 Hz
832 x 624	75 Hz
1024 x 768	60, 70, 75 Hz
1152 x 864	75 Hz
1152 x 870	75 Hz
1280 x 720	60 Hz
1280 x 960	60 Hz
1280 x 1024	60, 75 Hz
1360 x 768	60, 85 Hz
1366 x 768	60 Hz
1440 x 900	60 Hz
1600 x 1200	60 Hz
1680 x 1050	60 Hz
1920 x 1080	60 Hz
1920 x 1200	60 Hz
3840 x 2160	25, 30, 50, 60 Hz

USB Type C

Resolution	Refresh Rate (@)
640 x 480	60, 67, 72 Hz
800 x 600	56, 60, 72, 75 Hz
832 x 624	75 Hz
1024 x 768	60, 70, 75 Hz
1152 x 864	75 Hz
1152 x 870	75 Hz
1280 x 720	60 Hz
1280 x 960	60 Hz
1280 x 1024	60, 75 Hz
1360 x 768	60, 85 Hz
1366 x 768	60 Hz
1440 x 900	60 Hz
1600 x 1200	60 Hz
1680 x 1050	60 Hz
1920 x 1080	60 Hz
1920 x 1200	60 Hz
3840 x 2160	25, 30, 50, 60 Hz

VGA

Resolution	Refresh Rate (@)
640 x 480	60, 67, 72 Hz
800 x 600	56, 60, 72, 75 Hz
832 x 624	75 Hz
1024 x 768	60, 70, 75 Hz
1152 x 864	75 Hz
1152 x 870	75 Hz
1280 x 720	60 Hz
1280 x 960	60 Hz
1280 x 1024	60, 75 Hz
1360 x 768	60, 85 Hz
1366 x 768	60 Hz
1440 x 900	60 Hz
1600 x 1200	60 Hz
1680 x 1050	60 Hz
1920 x 1080	60 Hz
1920 x 1200	60 Hz

HDMI Out

Resolution	Refresh Rate (@)
720 x 480	60 Hz
1920 x 1080	60 Hz
3840 x 2160	60 Hz

Troubleshooting

This section describes some common problems that you may experience when using the ViewBoard.

Problem or Issue	Possible Solutions
Remote Control is not working	<ol style="list-style-type: none">1. Check whether something is obstructing the display's remote control receiver.2. Check whether the batteries in the remote control are installed correctly.3. Check whether the batteries need to be replaced.
The unit turns off unexpectedly	<ol style="list-style-type: none">1. Check whether Sleep mode is enabled.2. Check if there is a power outage in your area.3. Turn on the display and see if the problem is with the signal and control system.

PC Mode

Problem or Issue	Possible Solutions
No PC signal	<ol style="list-style-type: none">1. Check the display settings.2. Check the display resolution.3. Adjust the Hs & Vs (synchronization) settings using the OSD menu.
Background streaking	<ol style="list-style-type: none">1. Choose auto adjust.2. Adjust clock and phase.
Unsupported format	<ol style="list-style-type: none">1. Choose auto adjust.2. Adjust clock and phase settings.

Touch Function

Problem or Issue	Possible Solutions
Touch function does not work	<ol style="list-style-type: none">1. Check that drivers are installed correctly.2. Reinstall driver(s).3. Check setup and align it.4. Check whether the touch pen is working properly.

Video Not Working Properly

Problem or Issue	Possible Solutions
No picture/ No sound	<ol style="list-style-type: none">1. Check the Power status.2. Check the signal cable.3. Check that the internal PC is installed correctly.
Picture is unclear or cuts in and out	<ol style="list-style-type: none">1. Check the signal cable.2. Check if other electronics are interrupting the signal.
Poor picture	<ol style="list-style-type: none">1. Adjust chroma, brightness, and contrast settings in the menu.2. Check the signal cable.

Audio Not Working Properly

Problem or Issue	Possible Solutions
No sound	<ol style="list-style-type: none">1. Press the Mute/Unmute button.2. Adjust the volume.3. Check the audio cable.
One speaker only	<ol style="list-style-type: none">1. Adjust the sound balance in the menu.2. Check the sound control panel settings of the computer.3. Check the audio cable.

Maintenance

General Precautions

- Make sure the device is turned off and the power cable is unplugged from the power outlet.
- Never spray or pour any liquid directly onto the screen or case.
- Handle the device with care, as a darker-colored device, if scuffed, may show marks more clearly than a lighter-colored device.
- Do not use the system continuously for long periods of time.

Cleaning the Screen

- Wipe the screen with a clean, soft, lint-free cloth. This removes dust and other particles.
- If the screen is still not clean, apply a small amount of non-ammonia, non-alcohol based glass cleaner onto a clean, soft, lint-free cloth; then wipe the screen.

Cleaning the Case

- Use a soft, dry cloth.
- If the case is still not clean, apply a small amount of non-ammonia, non-alcohol based, mild non-abrasive detergent onto a clean, soft, lint-free cloth, then wipe the surface.

Disclaimer

- ViewSonic® does not recommend the use of any ammonia or alcohol-based cleaners on the display screen or case. Some chemical cleaners have been reported to damage the screen and/or case of the device.
- ViewSonic® will not be liable for damage resulting from use of any ammonia or alcohol-based cleaners.

NOTE: If condensation appears between the glass and the panel, keep the display turned on until the moisture disappears.

Regulatory and Service Information

Compliance Information

This section addresses all connected requirements and statements regarding regulations. Confirmed corresponding applications shall refer to nameplate labels and relevant markings on the unit.

FCC Compliance Statement

This device complies with part 15 of FCC Rules. Operation is subject to the following two conditions: (1) this device may not cause harmful interference, and (2) this device must accept any interference received, including interference that may cause undesired operation. This equipment has been tested and found to comply with the limits for a Class B digital device, pursuant to part 15 of the FCC Rules.

These limits are designed to provide reasonable protection against harmful interference in a residential installation. This equipment generates, uses, and can radiate radio frequency energy, and if not installed and used in accordance with the instructions, may cause harmful interference to radio communications. However, there is no guarantee that interference will not occur in a particular installation. If this equipment does cause harmful interference to radio or television reception, which can be determined by turning the equipment off and on, the user is encouraged to try to correct the interference by one or more of the following measures:

- Reorient or relocate the receiving antenna.
- Increase the separation between the equipment and receiver.
- Connect the equipment into an outlet on a circuit different from that to which the receiver is connected.
- Consult the dealer or an experienced radio/TV technician for help.

Warning: You are cautioned that changes or modifications not expressly approved by the party responsible for compliance could void your authority to operate the equipment.

Contains FCC ID: GSS-VS20736

Industry Canada Statement

CAN ICES (B) / NMB (B)

Contains IC ID: 4280A-VS20736

CE Conformity for European Countries

CE The device complies with the EMC Directive 2014/30/EU and Low Voltage Directive 2014/35/EU, Radio Equipment Directive 2014/53/EU and RoHS2 Directive 2011/65/EU & Annex II EU/2015/863.

The full declaration of conformity can be found at the following website:

- https://www.viewsonicglobal.com/public/products_download/safety_compliance/IFP/VS20432_CE_DoC.pdf
- https://www.viewsonicglobal.com/public/products_download/safety_compliance/IFP/VS20640_CE_DoC.pdf
- https://www.viewsonicglobal.com/public/products_download/safety_compliance/IFP/VS20641_CE_DoC.pdf
- https://www.viewsonicglobal.com/public/products_download/safety_compliance/IFP/VS20434_CE_DoC.pdf
- https://www.viewsonicglobal.com/public/products_download/safety_compliance/IFP/VS20435_CE_DoC.pdf

The following information is only for EU-member states:

The mark shown to the right is in compliance with the Waste Electrical and Electronic Equipment Directive 2012/19/EU (WEEE). The mark indicates the requirement NOT to dispose of the equipment as unsorted municipal waste, but use the return and collection systems according to local law.



The mark shown to the right is in compliance with the Waste Electrical and Electronic Equipment Directive 2012/19/EU (WEEE). The mark indicates the requirement NOT to dispose of the equipment as unsorted municipal waste, but use the return and collection systems according to local law.



Declaration of RoHS2 Compliance

This product has been designed and manufactured in compliance with Directive 2011/65/EU of the European Parliament and the Council on restriction of the use of certain hazardous substances in electrical and electronic equipment (RoHS2 Directive) and is deemed to comply with the maximum concentration values issued by the European Technical Adaptation Committee (TAC) as shown below:

Substance	Proposed Maximum Concentration	Actual Concentration
Lead (Pb)	0.1%	< 0.1%
Mercury (Hg)	0.1%	< 0.1%
Cadmium (Cd)	0.01%	< 0.01%
Hexavalent Chromium (Cr6 ⁺)	0.1%	< 0.1%
Polybrominated biphenyls (PBB)	0.1%	< 0.1%
Polybrominated diphenyl ethers (PBDE)	0.1%	< 0.1%
Bis (2-ethylhexyl) phthalate (DEHP)	0.1%	< 0.1%
Butyl benzyl phthalate (BBP)	0.1%	< 0.1%
Dibutyl phthalate (DBP)	0.1%	< 0.1%
Diisobutyl phthalate (DIBP)	0.1%	< 0.1%

Certain components of products as stated above are exempted under the Annex III of the RoHS2 Directives as noted below:

- Copper alloy containing up to 4% lead by weight.
- Lead in high melting temperature type solders (i.e. lead-based alloys containing 85% by weight or more lead).
- Electrical and electronic components containing lead in a glass or ceramic other than dielectric ceramic in capacitors, e.g. piezoelectronic devices, or in a glass or ceramic matrix compound.
- Lead in dielectric ceramic in capacitors for a rated voltage of 125V AC or 250V DC or higher.

ENERGY STAR Statement

ENERGY STAR is a U.S. Environmental Protection Agency voluntary program that helps businesses and individuals save money and protect our climate through superior energy efficiency. Products that earn the ENERGY STAR prevent greenhouse gas emissions by meeting strict energy efficiency criteria or requirements set by the U.S. Environmental Protection Agency.

As an ENERGY STAR Partner, ViewSonic is determined to meet the Energy star Guidelines and mark all certified models with the ENERGY STAR logo.

The following logo appears on all ENERGY STAR-certified models:



NOTE: The power management features significantly reduce energy consumption when the product is not in use. Power management allows the device to automatically enter a low power “sleep” mode after a defined period of inactivity. And the power management features also enter Sleep Mode or Off Mode within 5 minutes of being disconnected from a host computer. Please note any change in energy settings will increase energy consumption.

Indian Restriction of Hazardous Substances

Restriction on Hazardous Substances statement (India). This product complies with the “India E-waste Rule 2011” and prohibits use of lead, mercury, hexavalent chromium, polybrominated biphenyls or polybrominated diphenyl ethers in concentrations exceeding 0.1 weight % and 0.01 weight % for cadmium, except for the exemptions set in Schedule 2 of the Rule.

Product Disposal at End of Product Life

ViewSonic® respects the environment and is committed to working and living green. Thank you for being part of Smarter, Greener Computing. Please visit the ViewSonic® website to learn more.

USA & Canada:

<https://www.viewsonic.com/us/go-green-with-viewsonic>

Europe:

<https://www.viewsonic.com/eu/environmental-social-governance/recycle>

Taiwan:

<https://recycle.moenv.gov.tw/>

For EU users, please contact us for any safety/accident issue experienced with this product:

ViewSonic Europe Limited



Haaksbergweg 75
1101 BR Amsterdam
Netherlands



+31 (0) 650608655



EPREL@viewsoniceurope.com



<https://www.viewsonic.com/eu/>

Copyright Information

Copyright© ViewSonic® Corporation, 2024. All rights reserved.

Macintosh and Power Macintosh are registered trademarks of Apple Inc.

Microsoft, Windows, and the Windows logo are registered trademarks of Microsoft Corporation in the United States and other countries.

ViewSonic® and the three birds logo are registered trademarks of ViewSonic® Corporation.

VESA is a registered trademark of the Video Electronics Standards Association. DPMS, DisplayPort, and DDC are trademarks of VESA.

ENERGY STAR® is a registered trademark of the U.S. Environmental Protection Agency (EPA).

As an ENERGY STAR® partner, ViewSonic® Corporation has determined that this product meets the ENERGY STAR® guidelines for energy efficiency.

Disclaimer: ViewSonic® Corporation shall not be liable for technical or editorial errors or omissions contained herein; nor for incidental or consequential damages resulting from furnishing this material, or the performance or use of this product.

In the interest of continuing product improvement, ViewSonic® Corporation reserves the right to change product specifications without notice. Information in this document may change without notice.

No part of this document may be copied, reproduced, or transmitted by any means, for any purpose without prior written permission from ViewSonic® Corporation.



Customer Service

For technical support or product service, see the table below or contact your reseller.

NOTE: You will need the product's serial number.

Country/ Region	Website	Country/ Region	Website
Asia Pacific & Africa			
Australia	www.viewsonic.com/au/	Bangladesh	www.viewsonic.com/bd/
中国 (China)	www.viewsonic.com.cn	香港 (繁體中文)	www.viewsonic.com/hk/
Hong Kong (English)	www.viewsonic.com/hk-en/	India	www.viewsonic.com/in/
Indonesia	www.viewsonic.com/id/	Israel	www.viewsonic.com/il/
日本 (Japan)	www.viewsonic.com/jp/	Korea	www.viewsonic.com/kr/
Malaysia	www.viewsonic.com/my/	Middle East	www.viewsonic.com/me/
Myanmar	www.viewsonic.com/mm/	Nepal	www.viewsonic.com/np/
New Zealand	www.viewsonic.com/nz/	Pakistan	www.viewsonic.com/pk/
Philippines	www.viewsonic.com/ph/	Singapore	www.viewsonic.com/sg/
臺灣 (Taiwan)	www.viewsonic.com/tw/	ประเทศไทย	www.viewsonic.com/th/
Việt Nam	www.viewsonic.com/vn/	South Africa & Mauritius	www.viewsonic.com/za/
Americas			
United States	www.viewsonic.com/us	Canada	www.viewsonic.com/us
Latin America	www.viewsonic.com/la		
Europe			
Europe	www.viewsonic.com/eu/	France	www.viewsonic.com/fr/
Deutschland	www.viewsonic.com/de/	Қазақстан	www.viewsonic.com/kz/
Россия	www.viewsonic.com/ru/	España	www.viewsonic.com/es/
Türkiye	www.viewsonic.com/tr/	Україна	www.viewsonic.com/ua/
United Kingdom	www.viewsonic.com/uk/		

Limited Warranty

ViewSonic® Smart White Board

What the warranty covers:

ViewSonic® warrants its products to be free from defects in material and workmanship during the warranty period. If a product proves to be defective in material or workmanship during the warranty period, ViewSonic® will, at its sole option, and as your sole remedy, repair or replace the product with a similar product. Replacement Product or parts may include remanufactured or refurbished parts or components. The repair or replacement unit or parts or components will be covered by the balance of the time remaining on the customer's original limited warranty and the warranty period will not be extended. ViewSonic® provides no warranty for any third-party software whether included with the product or installed by the customer, installation of any unauthorized hardware parts or components (e.g. Projector Lamps). (Please refer to: "What the warranty excludes and does not cover" section).

Who the warranty protects:

This warranty is valid only for the first consumer purchaser.

What the warranty excludes and does not cover:

- Any product on which the serial number has been defaced, modified, or removed.
- Damage, deterioration, or malfunction resulting from:
 - » Accident, misuse, neglect, fire, water, lightning, or other acts of nature, unauthorized product modification, or failure to follow instructions supplied with the product.
 - » Repair or attempted repair by anyone not authorized by ViewSonic®.
 - » Damage to or loss of any programs, data, or removable storage media.
 - » Normal wear and tear.
 - » Removal or installation of the product.
- Software or data loss occurring during repair or replacement.
- Any damage of the product due to shipment.
- Causes external to the product, such as electric power fluctuations or failure.
- Use of supplies or parts not meeting ViewSonic's specifications.
- Failure of owner to perform periodic product maintenance as stated in the User Guide.

- Any other cause which does not relate to a product defect.
- Damage caused by static (non-moving) images displayed for lengthy periods of time (also referred to as image burn-in).
- Software - Any third-party software included with the product or installed by the customer.
- Hardware/Accessories/Parts/Components – Installation of any unauthorized hardware, accessories, consumable parts or components (e.g. Projector Lamps).
- Damage to, or abuse of, the coating on the surface of the display through inappropriate cleaning as described in the product User Guide.
- Removal, installation, and set-up service charges, including wall-mounting of the product.

How to get service:

- For information about receiving service under warranty, contact ViewSonic® Customer Support (Please refer to the “Customer Service” page). You will need to provide your product’s serial number.
- To obtain warranty service, you will be required to provide: (a) the original dated sales slip, (b) your name, (c) your address, (d) a description of the problem, and (e) the serial number of the product.
- Take or ship the product, freight prepaid, in the original container to an authorized ViewSonic® service center or ViewSonic®.
- For additional information or the name of the nearest ViewSonic® service center, contact ViewSonic®.

Limitation of implied warranties:

There are no warranties, express or implied, which extend beyond the description contained herein including the implied warranty of merchantability and fitness for a particular purpose.

Exclusion of damages:

ViewSonic's liability is limited to the cost of repair or replacement of the product. ViewSonic® shall not be liable for:

- Damage to other property caused by any defects in the product, damages based upon inconvenience, loss of use of the product, loss of time, loss of profits, loss of business opportunity, loss of goodwill, interference with business relationships, or other commercial loss, even if advised of the possibility of such damages.
- Any other damages, whether incidental, consequential or otherwise.
- Any claim against the customer by any other party.
- Repair or attempted repair by anyone not authorized by ViewSonic®.

Effect of state law:

This warranty gives you specific legal rights, and you may also have other rights which vary from state to state. Some states do not allow limitations on implied warranties and/or do not allow the exclusion of incidental or consequential damages, so the above limitations and exclusions may not apply to you.

Sales outside the U.S.A. and Canada:

For warranty information and service on ViewSonic® products sold outside of the U.S.A. and Canada, contact ViewSonic® or your local ViewSonic® dealer.

The warranty period for this product in mainland China (Hong Kong, Macao, and Taiwan Excluded) is subject to the terms and conditions of the Maintenance Guarantee Card.

For users in Europe and Russia, full details of warranty provided can be found at: <http://www.viewsonic.com/eu/> under "Support/Warranty Information".

Mexico Limited Warranty

ViewSonic® Smart White Board

What the warranty covers:

ViewSonic® warrants its products to be free from defects in material and workmanship, under normal use, during the warranty period. If a product proves to be defective in material or workmanship during the warranty period, ViewSonic® will, at its sole option, repair or replace the product with a like product. Replacement product or parts may include remanufactured or refurbished parts or components & accessories.

Who the warranty protects:

This warranty is valid only for the first consumer purchaser.

What the warranty excludes and does not cover:

- Any product on which the serial number has been defaced, modified or removed.
- Damage, deterioration, or malfunction resulting from:
 - » Accident, misuse, neglect, fire, water, lightning, or other acts of nature, unauthorized product modification, unauthorized attempted repair, or failure to follow instructions supplied with the product.
 - » Causes external to the product, such as electrical power fluctuations or failure.
 - » Use of supplies or parts not meeting ViewSonic®'s specifications.
 - » Normal wear and tear.
 - » Any other cause which does not relate to a product defect.
- Any product exhibiting a condition commonly known as “image burn-in” which results when a static image is displayed on the product for an extended period of time.
- Removal, installation, insurance, and set-up service charges.

How to get service:

For information about receiving service under warranty, contact ViewSonic® Customer Support (Please refer to the attached “Customer Service” page). You will need to provide your product’s serial number, so please record the product information in the space provided below on your purchase for your future use. Please retain your receipt of proof of purchase to support your warranty claim.

For Your Records

Product Name: _____ Model Number: _____
Document Number: _____ Serial Number: _____
Purchase Date: _____ Extended Warranty Purchase? _____(Y/N)
If so, what date does warranty expire? _____

- To obtain warranty service, you will be required to provide (a) the original dated sales slip, (b) your name, (c) your address, (d) a description of the problem, and (e) the serial number of the product.
- Take or ship the product, in the original container packaging, to an authorized ViewSonic® service center.
- Round trip transportation costs for in-warranty products will be paid by ViewSonic®.

Limitation of implied warranties:

There are no warranties, express or implied, which extend beyond the description contained herein including the implied warranty of merchantability and fitness for a particular purpose.

Exclusion of damages:

ViewSonic®’s liability is limited to the cost of repair or replacement of the product. ViewSonic® shall not be liable for:

- Damage to other property caused by any defects in the product, damages based upon inconvenience, loss of use of the product, loss of time, loss of profits, loss of business opportunity, loss of goodwill, interference with business relationships, or other commercial loss, even if advised of the possibility of such damages.
- Any other damages, whether incidental, consequential or otherwise.
- Any claim against the customer by any other party.
- Repair or attempted repair by anyone not authorized by ViewSonic®.

Contact Information for Sales & Authorized Service (Centro Autorizado de Servicio) within Mexico:	
Name, address, of manufacturer and importers: México, Av. de la Palma #8 Piso 2 Despacho 203, Corporativo Interpalmas, Col. San Fernando Huixquilucan, Estado de México Tel: (55) 3605-1099 http://www.viewsonic.com/la/soporte/index.htm	
NÚMERO GRATIS DE ASISTENCIA TÉCNICA PARA TODO MÉXICO: 001.866.823.2004	
Hermosillo: Distribuciones y Servicios Computacionales SA de CV. Calle Juarez 284 local 2 Col. Bugambilias C.P: 83140 Tel: 01-66-22-14-9005 E-Mail: disc2@hmo.megared.net.mx	Villahermosa: Compumantenimientos Garantizados, S.A. de C.V. AV. GREGORIO MENDEZ #1504 COL, FLORIDA C.P. 86040 Tel: 01 (993) 3 52 00 47 / 3522074 / 3 52 20 09 E-Mail: compumantenimientos@prodigy.net.mx
Puebla, Pue. (Matriz): RENTA Y DATOS, S.A. DE C.V. Domicilio: 29 SUR 721 COL. LA PAZ 72160 PUEBLA, PUE. Tel: 01(52).222.891.55.77 CON 10 LINEAS E-Mail: datos@puebla.megared.net.mx	Veracruz, Ver.: CONEXION Y DESARROLLO, S.A DE C.V. Av. Americas # 419 ENTRE PINZÓN Y ALVARADO Fracc. Reforma C.P. 91919 Tel: 01-22-91-00-31-67 E-Mail: gacosta@qplus.com.mx
Chihuahua: Soluciones Globales en Computación C. Magisterio # 3321 Col. Magisterial Chihuahua, Chih. Tel: 4136954 E-Mail: Cefeo@soluglobales.com	Cuernavaca: Compusupport de Cuernavaca SA de CV Francisco Leyva # 178 Col. Miguel Hidalgo C.P. 62040, Cuernavaca Morelos Tel: 01 777 3180579 / 01 777 3124014 E-Mail: aquevedo@compusupportcva.com
Distrito Federal: QPLUS, S.A. de C.V. Av. Coyoacán 931 Col. Del Valle 03100, México, D.F. Tel: 01(52)55-50-00-27-35 E-Mail : gacosta@qplus.com.mx	Guadalajara, Jal.: SERVICRECE, S.A. de C.V. Av. Niños Héroes # 2281 Col. Arcos Sur, Sector Juárez 44170, Guadalajara, Jalisco Tel: 01(52)33-36-15-15-43 E-Mail: mmiranda@servicrece.com
Guerrero Acapulco: GS Computación (Grupo Sesicomp) Progreso #6-A, Colo Centro 39300 Acapulco, Guerrero Tel: 744-48-32627	Monterrey: Global Product Services Mar Caribe # 1987, Esquina con Golfo Pérsico Fracc. Bernardo Reyes, CP 64280 Monterrey N.L. México Tel: 8129-5103 E-Mail: aydeem@gps1.com.mx
MERIDA: ELECTROSER Av Reforma No. 403Gx39 y 41 Mérida, Yucatán, México CP97000 Tel: (52) 999-925-1916 E-Mail: rrrb@sureste.com	Oaxaca, Oax.: CENTRO DE DISTRIBUCION Y SERVICIO, S.A. de C.V. Murguía # 708 P.A., Col. Centro, 68000, Oaxaca Tel: 01(52)95-15-15-22-22 Fax: 01(52)95-15-13-67-00 E-Mail: gpotai2001@hotmail.com
Tijuana: STD Av Ferrocarril Sonora #3780 L-C Col 20 de Noviembr Tijuana, Mexico	FOR USA SUPPORT: ViewSonic® Corporation 381 Brea Canyon Road, Walnut, CA. 91789 USA Tel: 800-688-6688 E-Mail: http://www.viewsonic.com



ViewSonic®